

Digital Copier

Operating Instructions (For Facsimile)

Model No.

DP-135FP

Options

UE-403171-AU

UE-410045/410046/410047

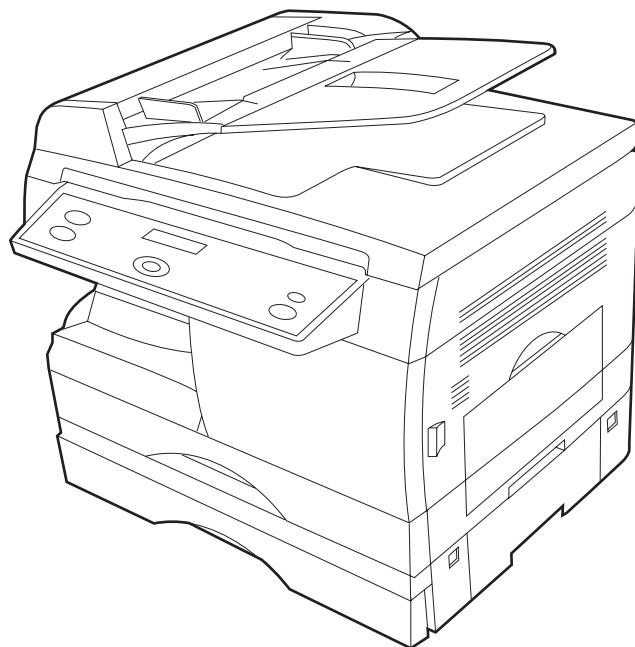

Before operating this equipment, please read these instructions completely and keep these operating instructions for future reference.

2

GETTING TO
KNOW YOUR
MACHINE

INSTALLING
YOUR MACHINE

PROGRAMMING
YOUR MACHINE

BASIC
OPERATIONS

ADVANCED
FEATURES

NETWORK
FEATURES

PRINTING
JOURNALS AND
LISTS

MAINTENANCE

APPENDIX

IMPORTANT INFORMATION

When requesting information, supplies or service always refer to the model and serial number of your machine. The model and serial number plate (Main Name Plate) is located on the machine as shown below. For your convenience, space is provided below to record information you may need in the future.

Model No. _____

Serial No. _____

Date of Purchase _____

Dealer _____

Address _____

Telephone Number

() - _____

Supplies Telephone Number

() - _____

Service Telephone Number

() - _____

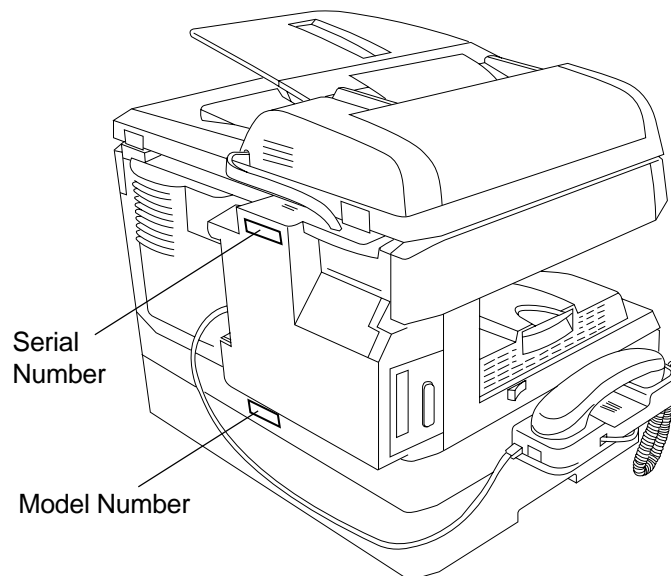

Useful for office, more than 4 functions

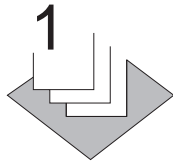
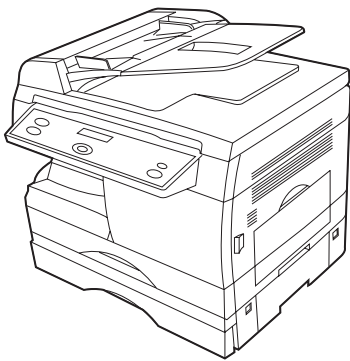

Copier

- Can copy up to Legal size.
- Available to copy text/photos/halftones originals.

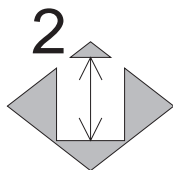

Facsimile

- Plain paper Super G3 compatible Fax.
- Can be used as a regular telephone with optional handset.



Printer

- Digital printer controller standard, printer resolution 300 or 600 dpi.

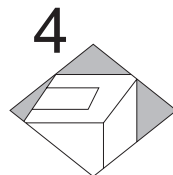

Scanner

- Black & White original scanner standard, scan resolution at up to 400 dpi.

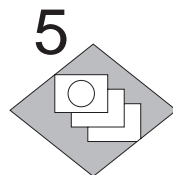

Application Software

- Document Manager
- Document Viewer
- Document Scanner
- Utilities (Status Monitor, Phone Book Editor, Device Configuration Editor)

DP-135FP Operating Instructions

This copier includes 3 operating instruction manuals, please use the correct manual when operator intervention is necessary.

<Copier>

Use the information provided in this manual whenever a copier function requires intervention. For example: how to make copies, add paper, replace the toner cartridge, etc..

<Facsimile>

Use the information provided in the DP-135FP Facsimile Operating Instructions manual whenever a fax function requires intervention. For example: how to send/receive a fax, or when a trouble message appears, etc..

<Printer>

&
<Other Advanced Functions>

Use the information provided on the enclosed CD for an explanation of how to use as a Printer, Scanner, Edit Directory Dialing Feature, Device Settings, Status Monitor, and/or Document Management System.

Operation Chart (For Facsimile)

How to Load Originals

(1) On the ADF

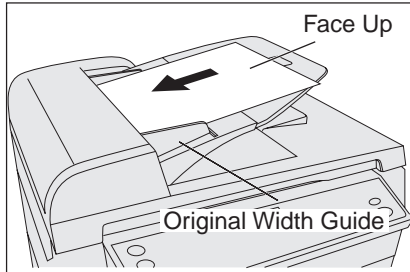

Place the original(s) Face Up on the ADF until the leading edge placed into the machine stops. Adjust the Original Width Guides to center the original(s) on the ADF.

(2) On the Platen Glass (Flatbed)

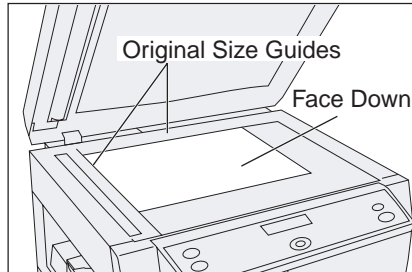

Place a book or an original Face Down on the Platen Glass, aligning it with the arrow mark on the Original Size Guides.

Basic Operation

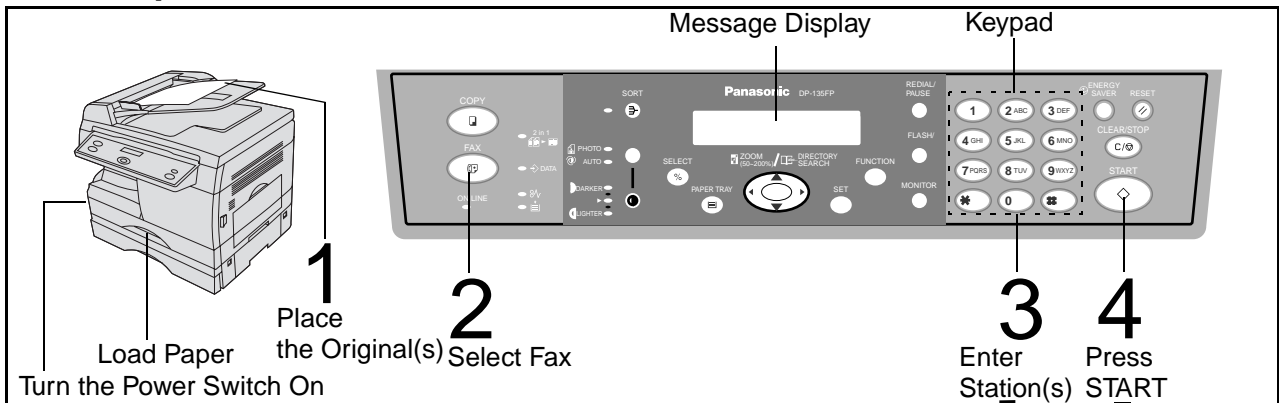

How to Dial (Manual Number Dialing)

Enter the station number using the keypad.

TEL. NO. (Max: 36 digits)

If you enter an incorrect number, press **CLEAR/STOP** to delete the last entry then re-enter the correct number.

When the original is placed on the Platen Glass.

This message appears.

Press **▼** or **▲** to select the size of the original.

Then, press **START** to start scanning.

If you have more than one original, press "1" (YES) and place another original on the Platen Glass, then press **START**. If there are no other originals, press "2" (NO).

Table of Contents

Getting To Know Your Machine

Precautions	9
■ For your safety	9
Overview	12
■ External View	12
■ Control panel	14
Function Selection	16
■ Selecting the Fax or Copy Mode	16

Installing Your Machine

Setting the Dialing Method (Tone or Pulse)	17
Adjusting the Volume	18
■ Setting the Monitor and / or Ringer Volume	18
■ Setting the Monitor Volume	18
■ Setting the Ringer Volume	19
How To Enter Characters	20
User Parameters	21
■ Setting the Date and Time	21
■ Setting Your LOGO	22
■ Setting Your Character ID	23
■ Setting Your ID Number (Fax Telephone Number)	24

Programming Your Machine

Directory Search Dialing	25
■ Entering the Directory Search Dialing	25
■ Changing Directory Search Dialing	27
■ Erasing the Directory Search Dialing	29
■ Setting Up Group Dialing	30
■ Changing Group Dialing	31
■ Erasing Group Dialing	33
Fax Parameters	34
■ Setting the Fax Parameters	34
■ Fax Parameter Table	35

Table of Contents

BASIC OPERATIONS

Loading Documents	39
Basic Transmission Settings	40
■ Original (Photo/Text)/Contrast/Resolution	40
■ Resolution	41
■ Communication Journal (COMM. JOURNAL)	42
Sending Documents	43
■ Memory Transmission	43
■ Manual Number Dialing	45
■ Directory Search Dialing	47
■ Multi-Station Transmission (Broadcasting)	49
■ Direct Transmission	51
■ Manual Number Dialing (Direct Transmission)	51
■ Directory Search Dialing (Direct Transmission)	53
■ Voice Mode Transmission	54
■ Off-Hook Dialing	54
■ On-Hook Dialing	55
■ Transmission Reservation	56
■ Memory Transmission Reservation (Multi-tasking)	56
■ Redialing	57
■ Automatic Redialing	57
■ Manual Redialing	57
Receiving Documents	58
■ Reception	58
■ Automatic Reception	58
■ Manual Reception	58
■ Print Reduction	59
■ Selecting the Print Reduction Mode	59
■ Receiving Oversize Documents	60
■ Substitute Memory Reception	61

Advanced Features

Polling	63
■ Setting the Polling Password	63
■ To Poll Documents from Another Station	64
Edit File Mode	66
■ Deleting a File	66
Receive To Memory	67
■ Setting RCV To Memory Password/Setting RCV to Memory	67
■ Setting the RCV To Memory Password	67
■ Setting RCV To Memory	68
■ Printing Out Documents	69

Network Features

Distinctive Ring Detector (DRD)	71
PIN Code Access	72
■ Selecting the Access Method (Prefix or Suffix)	72
■ Dialing with a PIN Code	73
Sub-Addressing	75
■ General Description	75
■ Setting the Sub-Address into the Directory Search Dialing Numbers	76
■ Sending a FAX with Sub-Address	77
■ Using Manual Number Dialing	78

Table of Contents

Printing Journals And Lists

Journals and Lists	79
■ Transaction Journal	79
■ Communication Journal (COMM. JOURNAL)	83
■ Directory Search Dialing List	85
■ FAX Parameter List	87

Maintenance

Troubleshooting	89
■ Information Codes	89
■ If You Have Any of These Problems	91
■ Adding Paper	92
■ Adding Toner	92
■ Removing Paper Jams	92
■ Replacing the Lithium Battery	93
■ Cleaning the Document Scanning Area	94
■ Cleaning the Printer Roller	95
■ Checking the Telephone Line	97

Appendix

Specifications	99
Options and Supplies	101
■ Installing the Handset Kit	102
■ Expansion Flash Memory Card	103
FCC Notice for User in USA	104
Notice for User in Canada	106
Glossary	108
ITU-T Image No.1	111

Energy Star



The DP-135FP complies with Tier 2 of the Environmental Protection Agency's Energy Star Program. This voluntary program specifies certain energy consumption and usage standards for copiers. These copiers will automatically "power down" after a specified period of non-use. The use of these Energy Star compliant copiers will reduce energy consumption and ultimately benefit the environment.

The default functions can be adjusted depending on your office requirements. Please see your authorized Panasonic dealer for more details.

Precautions

For your safety

■ Laser safety

LASER SAFETY

This unit employs a laser. Only qualified service personnel should attempt to service this device due to possible eye injury.

CAUTION:

USE OF CONTROLS, ADJUSTMENTS OR PERFORMANCE PROCEDURES OTHER THAN THOSE SPECIFIED HEREIN MAY RESULT IN HAZARDOUS RADIATION EXPOSURE.

■ Caution Labels

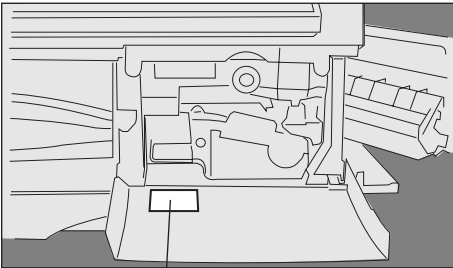

DANGER-Invisible laser radiation when open and interlock defeated.
AVOID DIRECT EXPOSURE TO BEAM.  FFPE2479

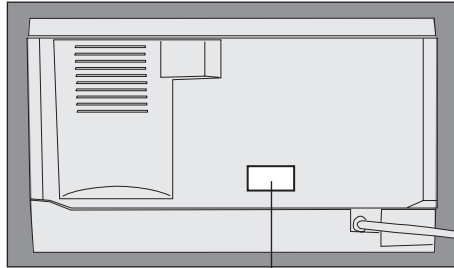

Product complies with DHHS Rules 21 CFR Subchapter J in effect at date of manufacture.

Matsushita Graphic Communication Systems, Inc.
Utsunomiya, Tochigi, Japan

MANUFACTURED:

Label when manufactured in Japan.

Product complies with DHHS Rules 21 CFR Subchapter J in effect at date of manufacture.

Matsushita Business Machine Corporation of the Philippines

Taytay, Rizal, Philippines

MANUFACTURED:

Label when manufactured in Philippines.

Precautions

Handling

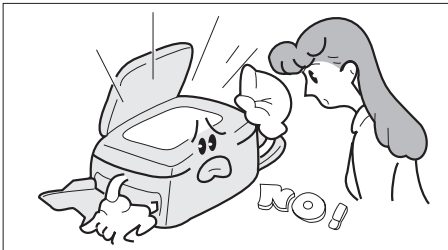

- Do not look directly at exposure lamp when copying.

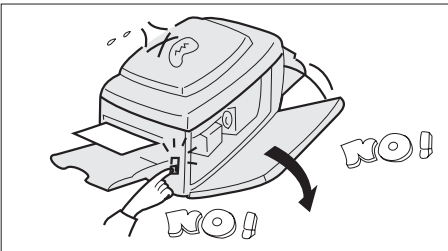

- Do not turn the power switch off or open the front panel during copying or printing.
- Do not drop paper clips or other metal objects into the copier.

Toner and Paper

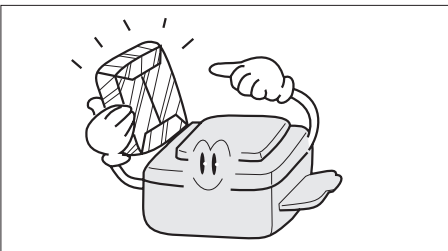

- Store toner, developer and paper in cool areas with low humidity.
- High quality paper of 16 lbs. - 24 lbs. (15 - 34 lbs. via sheet bypass) may be used.
- For optimum performance, it is recommended that only Panasonic Brand supplies are used in the copier.

Ventilation

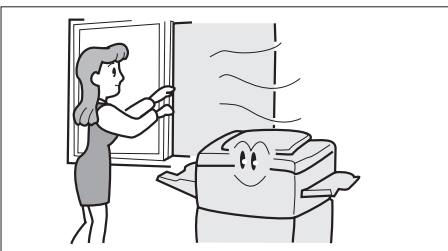

- The copier should be installed in a well-ventilated area to minimize the ozone density in the air.

Precautions

Installation

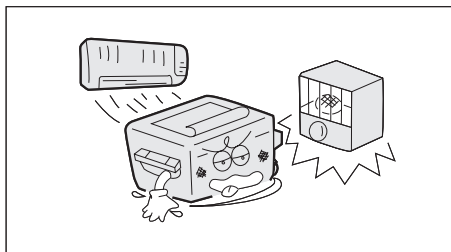

■ The copier should not be installed in areas with the following conditions:

- Extremely high or low temperature and humidity.
Proper ambient conditions are:
Temperature: 50°F - 90°F
Relative humidity: 30% - 80%
- Where temperature and humidity can change rapidly, causing condensation.
- Direct exposure to sunlight.
- Directly in the air conditioning flow.
- In areas of high dust concentration.
- In areas of poor ventilation.
- In areas with chemical fume concentration.
- In areas with extreme vibration.
- With unstable or uneven conditions (floors, etc.).



NOTE

1. The power consumption is 1.0 kW.
A properly wired (with ground), dedicated, 15A, 120V AC outlet is required. Do not use an extension cord.
The main plug on this equipment must be used to disconnect the main power. Please ensure that the socket outlet is installed near the equipment and shall be easily accessible.

Overview

External View

■ Front & Right Side View

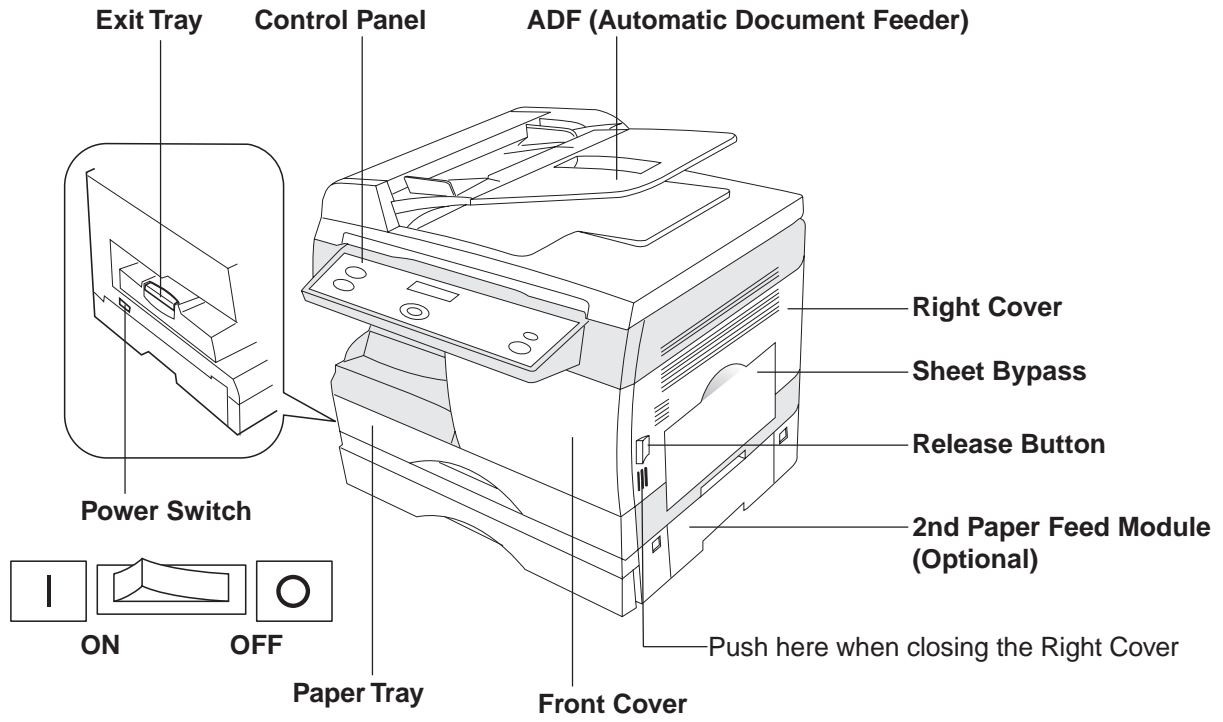

Overview

■ Rear & Left Side View

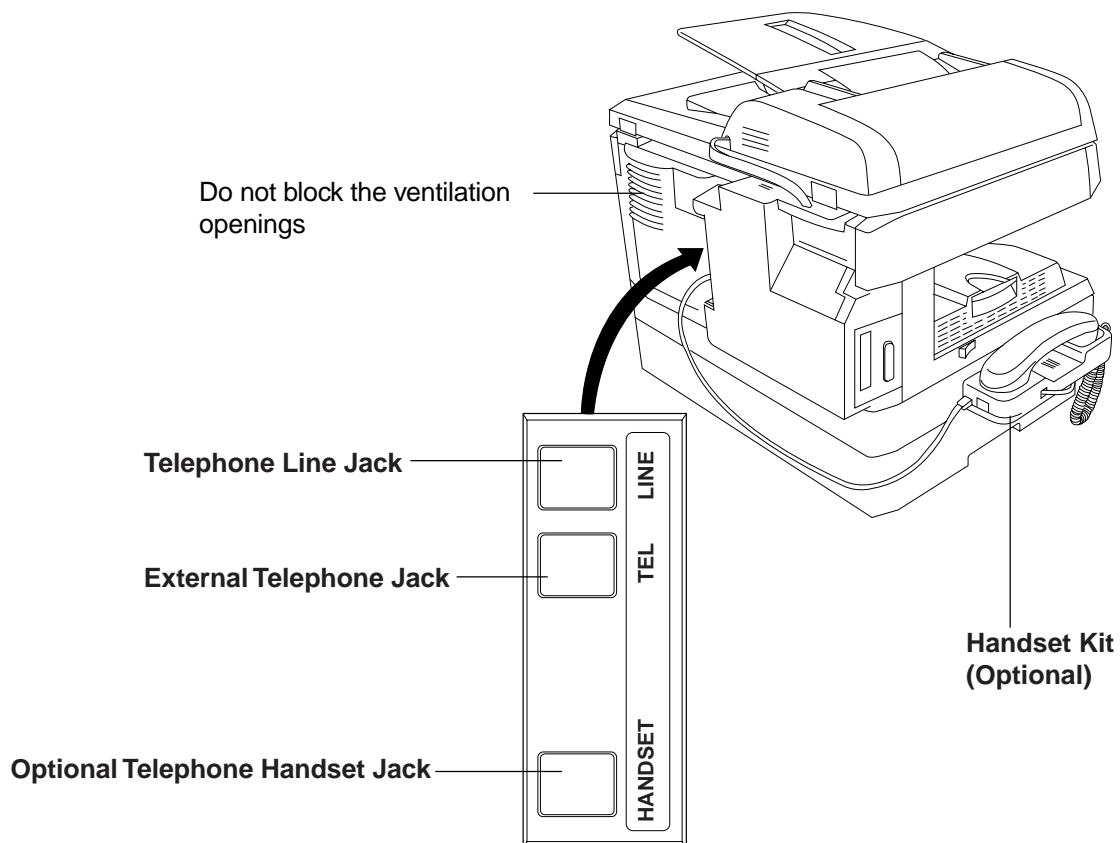

Overview

Control panel

■ Keys and Indicators (For Facsimile)

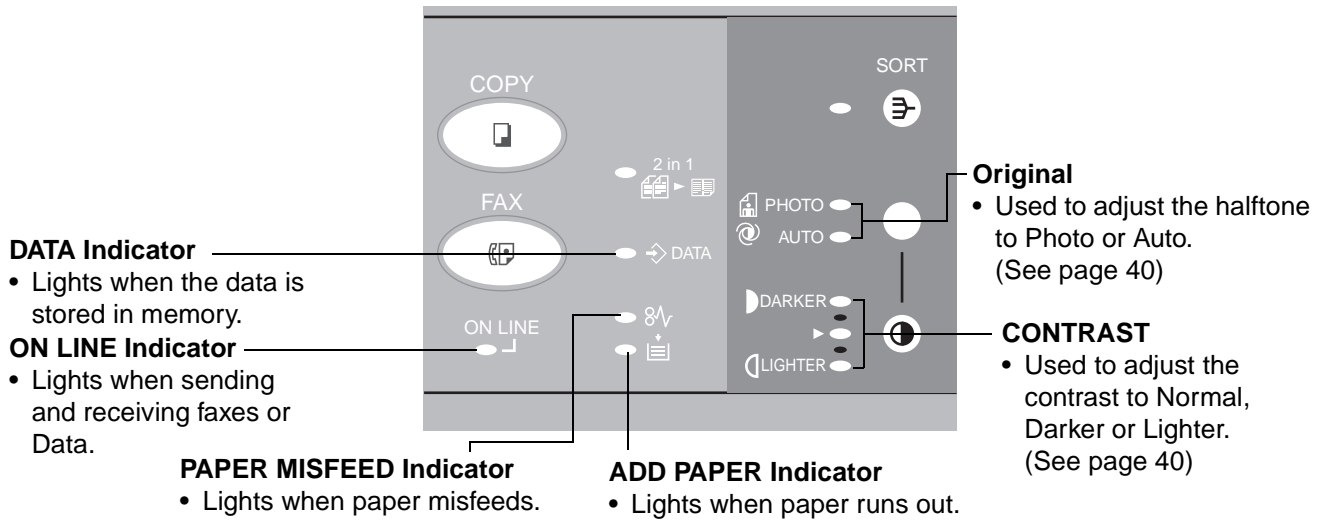
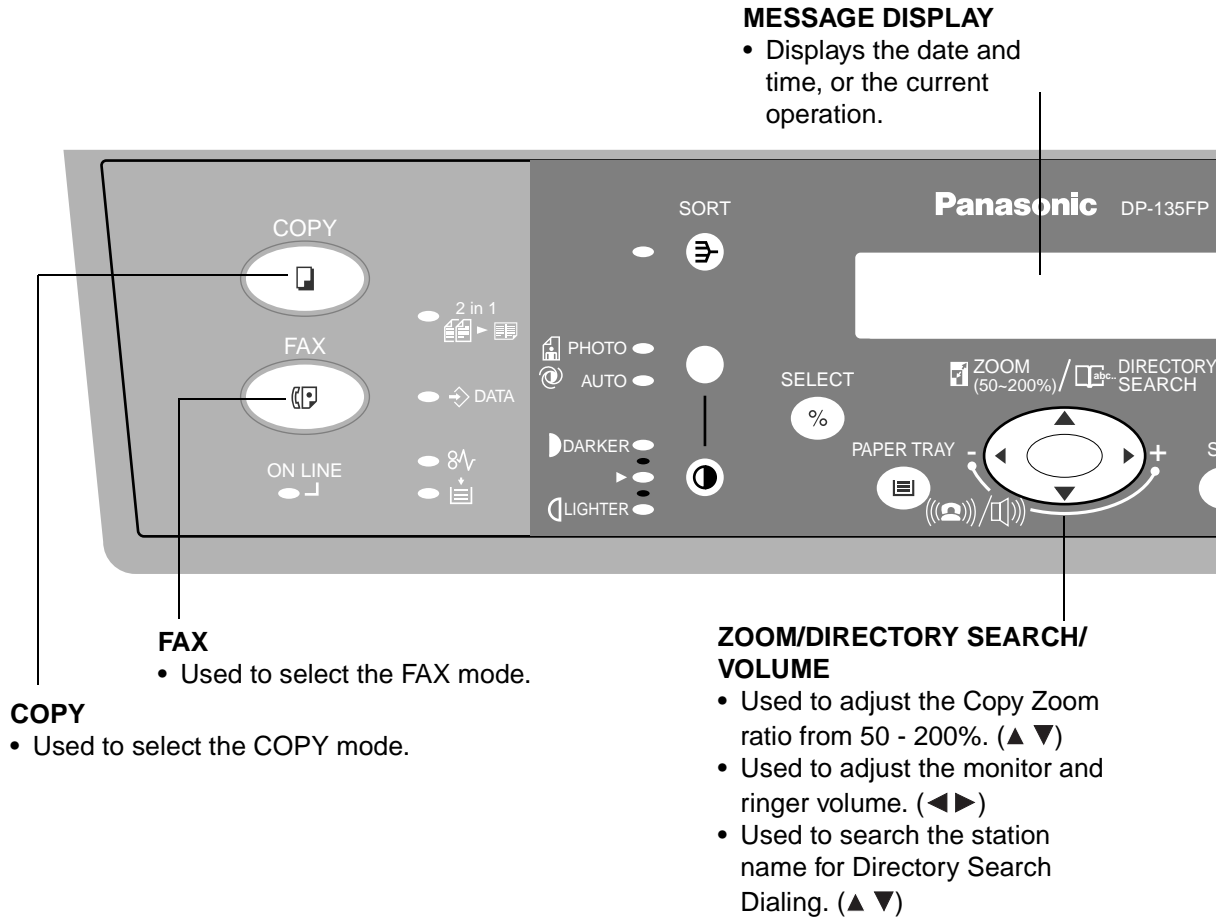

Overview

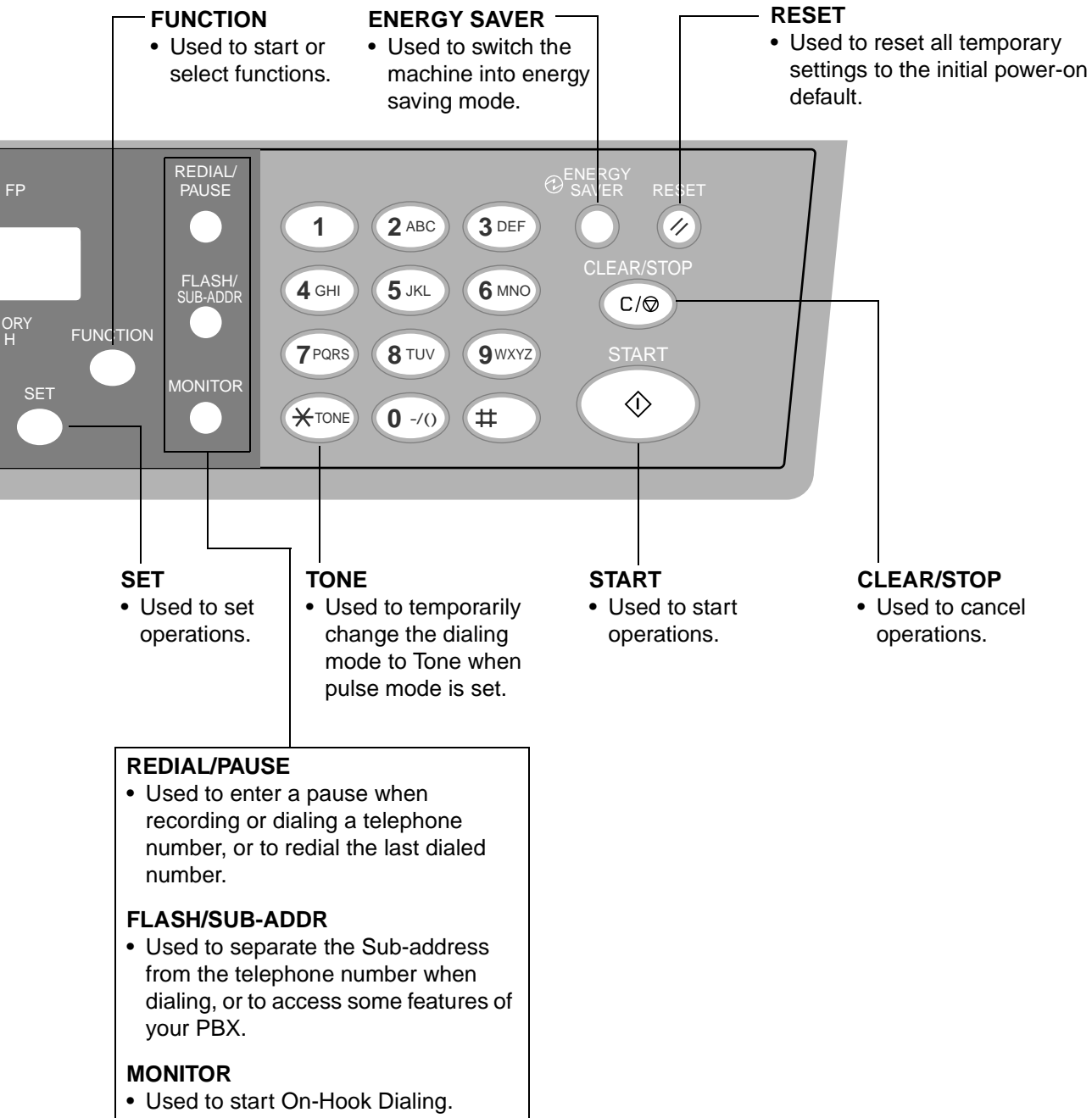

Function Selection

Selecting the Fax or Copy Mode

You can set the Power ON default mode to either Fax or Copy Mode. (See page 37)
Factory Standard Setting is Copy Mode.

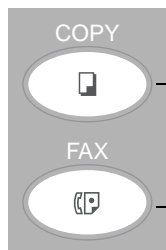
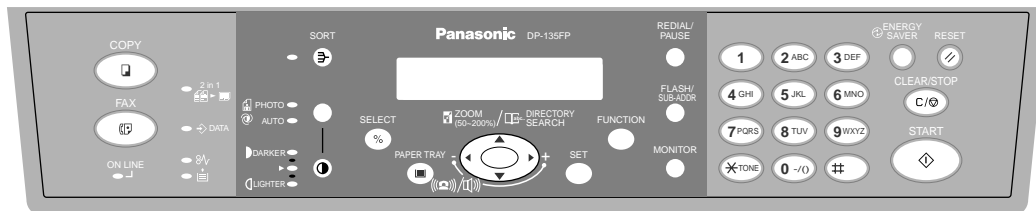

Copy Mode indicator

- Can receive Fax documents while Copy key is lit.

Fax Mode indicator

- Can send document(s) when the fax function is selected.

NOTE

1. Beep sound indicates unavailable combined operations.

Setting the Dialing Method (Tone or Pulse)

Your machine can operate with either of two dialing methods (Tone or Pulse), depending on the type of telephone line you are connected to. If you need to change the dialing method to Tone or Pulse, follow the procedure below.

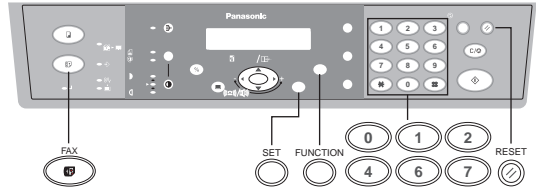

Make sure that the FAX Mode indicator is ON. If not, press **[FAX]** to select the "FAX MODE".

1

FUNCTION

SET MODE (1-6)
ENTER NO. OR ∨ ^

2

4 SET

FAX PARAMETER (02-99)
NO. =■

3

0 6 SET

06 DIALING METHOD
2 : TONE

4

1 for "PULSE".

06 DIALING METHOD
1 : PULSE

or

or

2 for "TONE".

06 DIALING METHOD
2 : TONE

5

SET RESET

Adjusting the Volume

Setting the Monitor and / or Ringer Volume

You can adjust the monitor and ringer volume on your machine. The built-in speaker enables you to hear the dial tone, dialing signals, and busy tone. The ringer sounds when your machine receives a call.

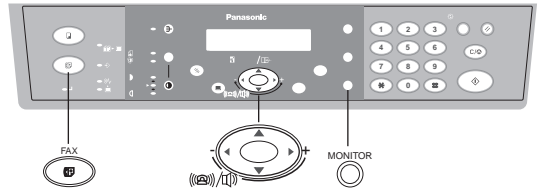

Make sure that the FAX Mode indicator is ON. If not, press **[FAX]** to select the "FAX MODE".

Setting the Monitor Volume

1



You will hear the dial tone through the speaker.

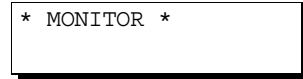

2

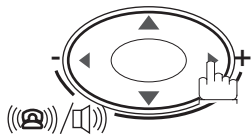

repeatedly to raise the volume.

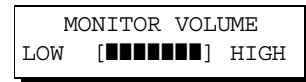

or

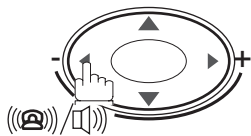

repeatedly to lower the volume.

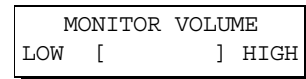

3



Adjusting the Volume

Setting the Ringer Volume

1

Standby

OCT-12-2000 15:00
00%

2

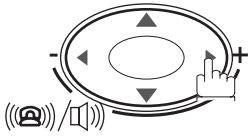

repeatedly to raise the volume.

RINGER VOLUME
(((📞)))

or

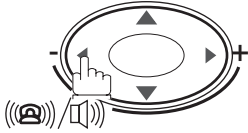

repeatedly to lower the volume.

RINGER VOLUME
📞

NOTE

1. You can also adjust the volume of the key touch tone and the volume of the buzzer in the Fax Parameter No. 10 (KEY/BUZZER VOLUME). (See page 35)

How To Enter Characters

To enter characters or symbols for the Station Name (See page 25), Logo (See page 22), Character ID (See page 23), etc., follow the steps below.

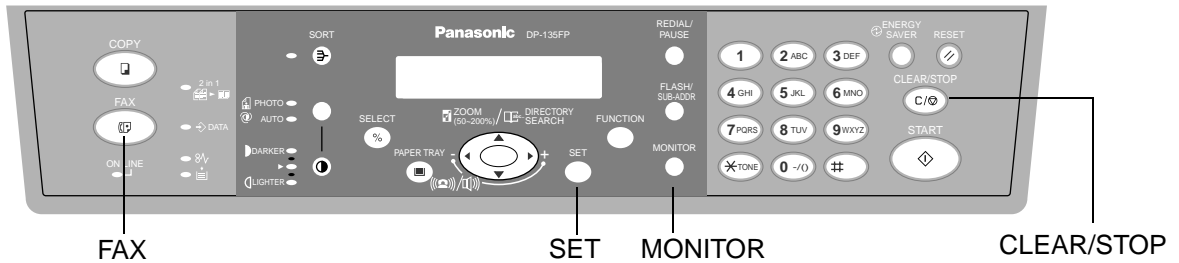

- Use ① to ⑨ to enter characters and symbols. The keypad assignment for the characters and symbols is shown below.

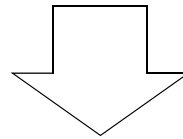

Ex: LOGO

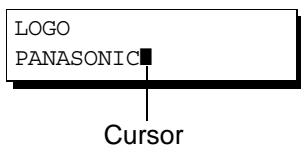

To enter "PANASONIC"

Character	Keypad	Key Strokes
P	⑦	1
A	②	1
N	⑥	2
A	②	1
S	⑦	4
O	⑥	3
N	⑥	2
I	④	3
C	②	3

	Characters and number of key strokes													
	1	2	3	4	5	6	7	8	9	10	11	12	13	14
①	1													
②	A	B	C	a	b	c	2							
③	D	E	F	d	e	f	3							
④	G	H	I	g	h	i	4							
⑤	J	K	L	j	k	l	5							
⑥	M	N	O	m	n	o	6							
⑦	P	Q	R	S	p	q	r	s	7					
⑧	T	U	V	t	u	v	8							
⑨	W	X	Y	Z	w	x	y	z	9					
⑩-/0	-	/	()	.	,	'	:	;	&	+	=	0	

- Select and continue pressing the appropriate key on the keypad until the desired Character / Symbol is displayed, then select another key on the keypad to enter other Characters / Symbols. If the next Character / Symbol that you wish to enter falls on the same key, press to set the first Character / Symbol first before continuing. Press to complete the registration.

Ex: To set "O" and "N", the ⑥ key is used for both

Characters. Set as follows: ⑥ ⑥ ⑥ ⑥ ⑥

- To delete a Character / Symbol, press
- To enter a space, press



User Parameters

Your machine has several basic settings (User Parameters) to help you keep records of the documents you send or receive. For example, the built-in clock keeps the current date and time, and your LOGO and ID Number help to identify you when you send or receive documents.

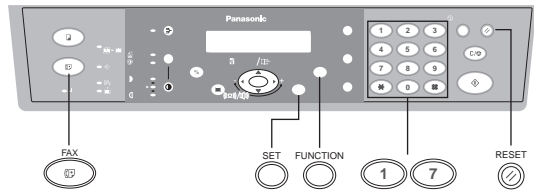

Setting the Date and Time

At standby the display will show the date and time. Once the standby display is set, it will automatically be updated.

Make sure that the FAX Mode indicator is ON. If not, press **[FAX]** to select the "FAX MODE".

1

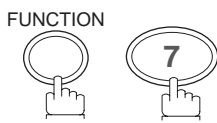

SET MODE (1-6)
ENTER NO. OR ∨ ^

2



1:USER PARAMETERS ?
PRESS SET TO SELECT

3



DATE & TIME
■ 1-01-1999 00:00

4

Enter the new date and time.

Ex: ① ① Month : October
① ② Date : 12th
② ① ① ① Year : 2000
① ⑤ ① ① Time : 3:00 PM

DATE & TIME
10-12-2000 15:00

If you make a mistake, use ◀ or ▶ to move the cursor over the incorrect number, then overwrite it with a correct one.

5

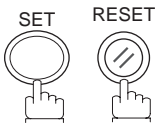

NOTE

- The clock of your machine is equipped with D.S.T. (Daylight Saving Time) system. So, your clock will automatically set the time forward from 2:00 AM to 3:00 AM on the first Sunday of April and set the time back from 2:00 AM to 1:00 AM on the last Sunday of October. If your state does not use the D.S.T. system, change the Fax Parameter No. 35 (DAYLIGHT TIME) to "Invalid". (See page 36)
- The current Date & Time must be set because it is required by the Telephone Consumer Act of 1991. (For details, see FCC NOTICE at the end of this Operating Instructions)

User Parameters

Setting Your LOGO

When you send a document, your LOGO appears on the top of the copy printed out at the other station.

The LOGO helps to identify you to someone who receives your document.

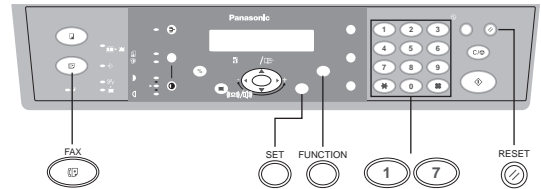

Make sure that the FAX Mode indicator is ON. If not, press **[FAX]** to select the "FAX MODE".

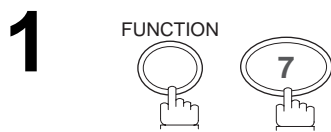

```
SET MODE      (1-6)
ENTER NO. OR ∨ ^
```

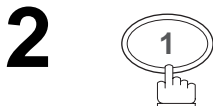

```
1:USER PARAMETERS ?
PRESS SET TO SELECT
```

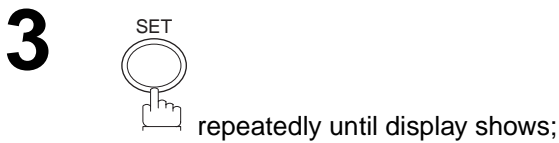

```
LOGO
█
```

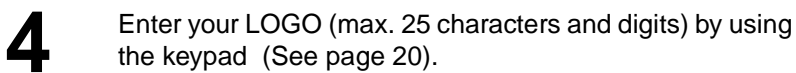

Ex: PANASONIC

```
LOGO
PANASONIC █
```

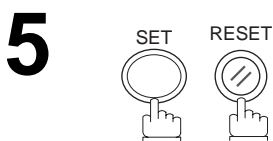

NOTE

1. Your Company Name or your name must be set as your LOGO because it is required by the Telephone Consumer Act of 1991. (For details, see FCC NOTICE at the end of this Operating Instructions)

User Parameters

Setting Your Character ID

If the remote machine has Character ID capabilities, when you are sending or receiving, your Character ID will appear on the remote machine's display and the remote machine's Character ID will appear on your display.

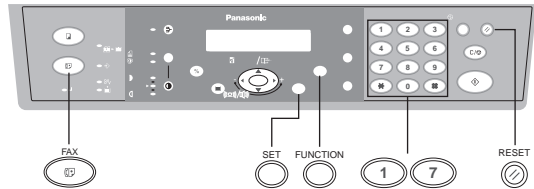

Make sure that the FAX Mode indicator is ON. If not, press **FAX** to select the "FAX MODE".

1

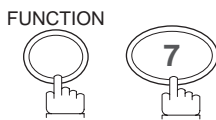

SET MODE (1-6)
ENTER NO. OR ∨ ^

2



1:USER PARAMETERS ?
PRESS SET TO SELECT

3



repeatedly until display shows;

CHARACTER ID
█

4

Enter your Character ID (max. 16 characters and digits) by using the keypad (See page 20).

Ex: HEAD OFFICE

CHARACTER ID
HEAD OFFICE█

5

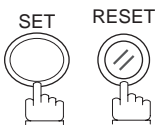

User Parameters

Setting Your ID Number (Fax Telephone Number)

If the remote machine does not have a Character ID but has an ID Number, when sending or receiving, your ID Number will appear on the remote machine's display and their ID Number will appear on your display.

We suggest you use your facsimile telephone number as your ID number. (max. 20 digits)

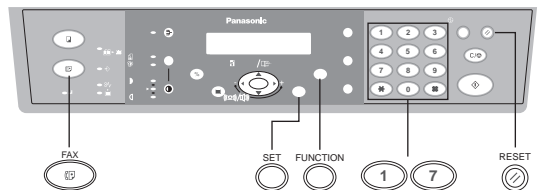

Make sure that the FAX Mode indicator is ON. If not, press **[FAX]** to select the "FAX MODE".

1

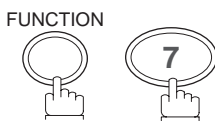

SET MODE (1-6)
ENTER NO. OR \vee \wedge

2



1:USER PARAMETERS ?
PRESS SET TO SELECT

3



repeatedly until display shows;

ID NO.

4

Enter your ID (max. 20 digits) by using the keypad and **[MONITOR]**.

Ex: **[2]** **[0]** **[1]** **[MONITOR]** **[5]** **[5]** **[5]**
[MONITOR] **[1]** **[2]** **[1]** **[2]**

ID NO.
201 555 1212

If you make a mistake, use **[◀]** or **[▶]** to move the cursor beyond the incorrect number, press **[CLEAR/STOP]** then re-enter the new number.

5

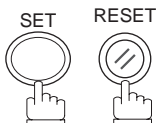

NOTE

- You may use **[*]** to enter a "+" character at the beginning of the ID number to indicate the following digit(s) for your country code.
Ex :+1 201 555 1212 +1 for U.S.A. country code.
 +81 3 111 2345 +81 for Japan country code.
- Your Fax Telephone Number must be set as your ID Number because it is required by the Telephone Consumer Act of 1991. (For details, see FCC NOTICE at the end of this Operating Instructions)

Directory Search Dialing

Entering the Directory Search Dialing

To use the Directory Search Dialing, you must first store the station names and their telephone numbers using the following procedure.

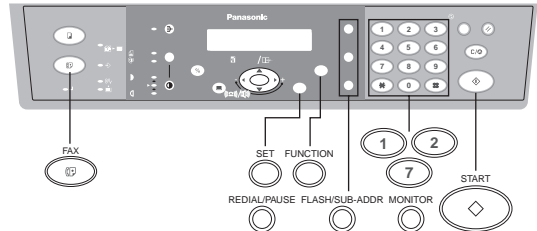

Make sure that the FAX Mode indicator is ON. If not, press **FAX** to select the "FAX MODE".

- 1** FUNCTION 7

SET MODE (1-6)
 ENTER NO. OR ∨ ^

- 2** 2 SET

DIR. STN. DIAL (1-3)
 ENTER NO. OR ∨ ^

- 3** 1

1:ADD STATION
 PRESS SET TO SELECT

- 4** SET

REGISTERED ENTRIES
 STN(S) : 0 GROUPS : 0

 ↓3 sec. later
 ENTER NAME
 ■

- 5** Enter the station name from the keypad
 (up to 15 characters). (See Note below and page 20)

Ex: **S A L E S M O N I T O R D E P T**

ENTER NAME
 SALES DEPT ■

- 6** SET

ENTER TEL. NO.
 ■

Directory Search Dialing

7 Enter the telephone number
(up to 36 digits including pauses and spaces).

```
ENTER TEL. NO.  
9-555 1234■
```

Ex: (9) [REDIAL/PAUSE] (5) (5) (5)
[MONITOR] (1) (2) (3) (4)

8

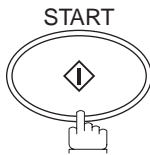

To record another station, repeat steps 5 to 8.
To return to standby, press [RESET].

```
REGISTERED ENTRIES  
STN(S) : 1   GROUPS : 0
```

↓3.0 sec. later

```
ENTER NAME  
■
```

Directory Search Dialing

Changing Directory Search Dialing

If you have to change any of the Directory Search Dialing Stations, follow the steps below.

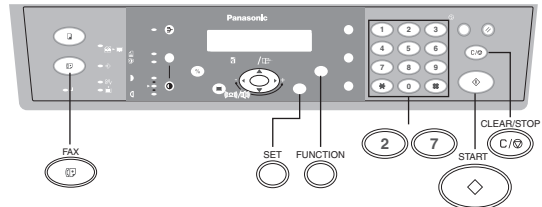

Make sure that the FAX Mode indicator is ON. If not, press **FAX** to select the "FAX MODE".

- 1**

FUNCTION 7 2 SET

DIR. STN. DIAL (1-3)
ENTER NO. OR ∨ ^
- 2**

2

2:MODIFY STATION
PRESS SET TO SELECT
- 3**

SET

REGISTERED ENTRIES
STN(S) : 15 GROUPS : 3

↓3.0 sec. later

PRESS ∨ ^ TO SELECT
THEN SET TO MODIFY
- 4**

Use ▼ or ▲ to search the station you wish to change.

SET

ENTER NAME
PANASONIC
- 5**

CLEAR/STOP
C/⊕

then enter a new station name. (See Note 1)

Ex: P A N A F A X

ENTER NAME
PANAFAX
- 6**

SET

ENTER TEL. NO.
9-555 1234

Directory Search Dialing

7

CLEAR/STOP



then enter a new telephone number.
(See Note 1)

ENTER TEL. NO.
9-555-3456

Ex: 9 REDIAL/PAUSE 5 5 5

MONITOR 3 4 5 6

8

START

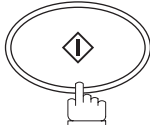

To return to standby, press RESET

PANAFAX
9-555 3456

NOTE

1. If you make a mistake, use ◀ or ▶ to move the cursor beyond the incorrect number, press CLEAR/STOP then re-enter the new number.
2. If the Directory Search Dialing Station has been used for a communication reservation, the settings cannot be changed or erased until the communication has finished.
To change or erase the settings, cancel the communication first by Edit File Mode. (See page 66)

Directory Search Dialing

Erasing the Directory Search Dialing

If you have to erase any of the Directory Search Dialing Stations, follow the steps below.

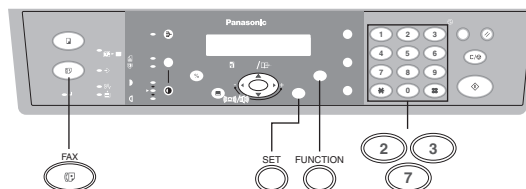

Make sure that the FAX Mode indicator is ON. If not, press **[FAX]** to select the "FAX MODE".

1

DIR. STN. DIAL (1-3)
ENTER NO. OR ∨ ^

2

3:DELETE STATION
PRESS SET TO SELECT

3

REGISTERED ENTRIES
STN(S):15 GROUPS:3

↓3.0 sec. later

PRESS ∨ ^ TO SELECT
THEN SET TO DELETE

4

Use ▼ or ▲ to search the station you wish to delete.

PANAFAX
PRESS SET TO CONFIRM

5

REGISTERED ENTRIES
STN(S):14 GROUPS:3

↓3.0 sec. later

PRESS ∨ ^ TO SELECT
THEN SET TO DELETE

To return to standby, press **[RESET]**.

3:DELETE STATION
PRESS SET TO SELECT

(When all stations were deleted)

NOTE

- If the Directory Search Dialing Station has been used for a communication reservation, the settings cannot be changed or erased until the communication has finished.
To change or erase the settings, cancel the communication first by Edit File Mode. (See page 66)



Directory Search Dialing

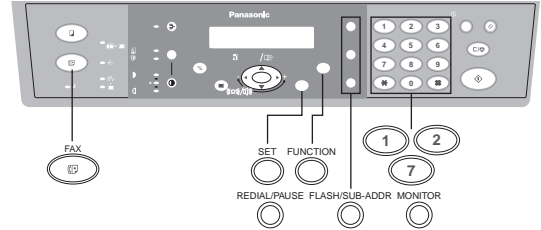

Setting Up Group Dialing

To set a Group Dialing, follow the steps below.



Make sure that the FAX Mode indicator is ON. If not, press **[FAX]** to select the "FAX MODE".

- 1**  

SET MODE (1-6)
 ENTER NO. OR √ ^
- 2**  

DIR. GROUP DIAL (1-3)
 ENTER NO. OR √ ^
- 3** 

1:ADD GROUP
 PRESS SET TO SELECT
- 4** 

REGISTERED ENTRIES
 STN(S) : 0 GROUPS : 0
 ↓3.0 sec. later
 ENTER NAME
- 5** Enter a Group name using character keys (up to 15 characters). (See page 20)

Ex: **S** **A** **L** **E** **S** **M** **O** **N** **I** **T** **O** **R** **D** **E** **P** **T**

ENTER NAME
 SALES DEPT
- 6** 

ENTER TEL. NO. 01/01
- 7** Enter the telephone number (up to 36 digits including pauses and spaces).

Ex: **9** **[RE]** **[DIAL/PAUSE]** **5** **5** **5** **[MONITOR]** **1** **2** **3** **4**

ENTER TEL. NO. 01/01
 9-555 1234
- 8** 

ENTER TEL. NO. 02/02

Enter the next telephone number and press **[START]** (up to 10 telephone numbers).

To record another Group, repeat steps 5 to 8 (up to 10 Groups).

To return to standby, press **[RESET]**.

Directory Search Dialing

Changing Group Dialing

If you have to change the Group Dialing, follow the steps below.

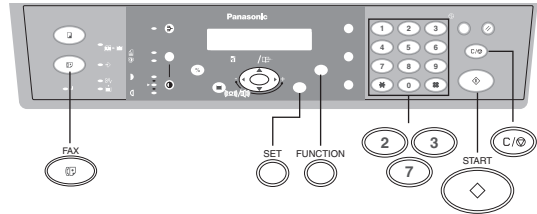

Make sure that the FAX Mode indicator is ON. If not, press **[FAX]** to select the "FAX MODE".

- 1** FUNCTION 7 3 SET

DIR.GROUP DIAL (1-3)
ENTER NO. OR ∨ ^
- 2** 2

2:MODIFY GROUP
PRESS SET TO SELECT
- 3** SET

REGISTERED ENTRIES
STN(S) : 15 GROUPS : 3

↓3.0 sec. later

PRESS ∨ ^ TO SELECT
THEN SET TO MODIFY
- 4** Use ▼ or ▲ to search the Group you wish to change.

ENTER NAME
PANASONIC
- 5** CLEAR/STOP



then enter a new Group name. (See Note 1)

Ex: P A N A F A X

ENTER NAME
PANAFAX█
- 6** SET

ENTER TEL. NO. 01/03
555 1234

Directory Search Dialing

7 Use  or  to search a telephone number you wish to change.

8

CLEAR/STOP



then enter a new telephone number.
(See Note 1)

ENTER TEL.NO. (01/03)
9-555 3456

Ex:          

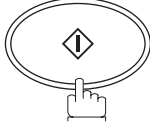

9

START



To return to standby, press 

NOTE

1. If you make a mistake, use  or  to move the cursor beyond the incorrect number, press  then re-enter the new number.
2. If the Group has been used for a communication reservation, the settings cannot be changed or erased until the communication has finished.
To change or erase the settings, cancel the communication first by Edit File Mode. (See page 66)

Directory Search Dialing

Erasing Group Dialing

If you have to erase a Group, follow the steps below.

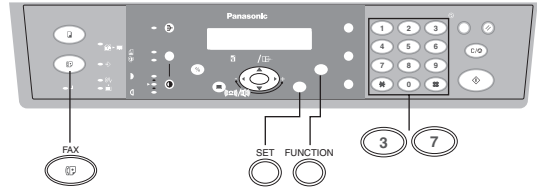

Make sure that the FAX Mode indicator is ON. If not, press **FAX** to select the "FAX MODE".

- 1**

FUNCTION 7 3 SET

DIR.GROUP DIAL (1-3)
ENTER NO. OR ∨ ^
- 2**

3

3:DELETE GROUP
PRESS SET TO SELECT
- 3**

SET

REGISTERED ENTRIES
STN(S):15 GROUPS:3

↓3.0 sec. later

PRESS ∨ ^ TO SELECT
THEN SET TO DELETE
- 4**

Use ▼ or ▲ to search the Group name you wish to change.

SET

PANASONIC <G>
PRESS SET TO CONFIRM
- 5**

SET

REGISTERED ENTRIES
STN(S):15 GROUPS:2

↓3.0 sec. later

PRESS ∨ ^ TO SELECT
THEN SET TO DELETE

3:DELETE GROUP
PRESS SET TO SELECT

(When all stations were deleted)

To delete another Group, repeat steps 4 to 5.

NOTE

1. If the Group has been used for a communication reservation, the settings cannot be changed or erased until the communication has finished.

To change or erase the settings, cancel the communication first by Edit File Mode. (See page 66)

Fax Parameters

Setting the Fax Parameters

Your facsimile machine has a variety of adjustable Fax Parameters. These parameters, listed in the Parameter Table, are preset for you and do not need to be changed. If you do want to make a change, read the table carefully.

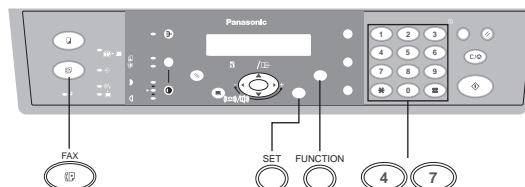

Make sure that the FAX Mode indicator is ON. If not, press **[FAX]** to select the "FAX MODE".

- 1**

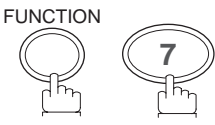

SET MODE (1-6)
 ENTER NO. OR ∇ \blacktriangle
- 2**

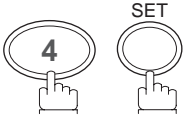

FAX PARAMETER (02-99)
 NO. = \blacksquare
- 3**

Enter Fax Parameter number from the Parameter Table.
(See pages 35 to 37)

Ex: ① ② for **RESOLUTION**

FAX PARAMETER (02-99)
 NO. = 02
- 4**



02 RESOLUTION
 1 : STANDARD
- 5**

Enter the new setting value.

Ex: ② for **FINE**

02 RESOLUTION
 2 : FINE
- 6**



05 MEMORY
 2 : ON

To set another parameter, press **[CLEAR/STOP]** to return to step 3 or press **[RESET]** to return to standby.

NOTE

1. To scroll the Fax Parameters in steps 2 or 4, press \blacktriangledown or \blacktriangle .
2. To print out a Fax Parameter List, see page 86.

Fax Parameters

Fax Parameter Table

No.	Parameter	Setting Number	Setting	Comments
02	RESOLUTION	*1	Standard	Setting the home position for the RESOLUTION.
		2	Fine	
		3	S-Fine	
05	MEMORY	1	Off	Setting the home position for the MEMORY.
		*2	On	
06	DIALING METHOD	1	Pulse	Selecting the dialing method.
		*2	Tone	
07	HEADER PRINT	*1	Inside	Selecting the printing position of the header. Inside : Inside TX copy area. Outside : Outside TX copy area. No print : Header is not printed.
		2	Outside	
		3	No print	
08	HEADER FORMAT	*1	Logo, ID No.	Selecting the header format.
		2	From To	
10	KEY/BUZZER VOLUME	1	Off	Selecting the volume of the Key/Buzzer tone.
		*2	Soft	
		3	Loud	
12	COMM. JOURNAL	1	Off	Selecting the home position of printout mode for COMM. Journal Off/Always/INC. Off : Does not print Always : Always prints Inc. only : Prints only when communication has failed.
		2	Always	
		*3	Inc. only	
13	AUTO JOURNAL PRINT	1	Invalid	Selecting whether the machine prints the journal automatically after every 40 transactions.
		*2	Valid	
17	RECEIVE MODE	1	Manual	Setting the reception mode to automatic or manual.
		*2	Auto	
22	SUBSTITUTE RCV	1	Invalid	Selecting whether the machine receives to memory when recording paper runs out, toner runs out or recording paper is jammed.
		*2	Valid	
24	PRINT REDUCTION	1	Fixed	Selecting print reduction mode. Fixed: Reduce received document according to setting of Parameter No. 25. Auto: Reduce received document according to the length of received documents.
		*2	Auto	
25	REDUCTION RATIO	70	70%	Selecting fixed print reduction ratio from 70% to 100%. This parameter functions only when fixed print reduction is selected on Fax Parameter No. 24.
		----	----	
		*100	100%	
26	POLLING PASSWORD		(----	Setting a 4-digit password for secured polling. (See page 63)

Continued on the next page.

Fax Parameters

No.	Parameter	Setting Number	Setting	Comments
34	ENERGY SAVE TIMER	1	5 min.	To reduce the power consumption in standby, your machine is designed to power down to the Energy Saver Mode and Sleep Mode after a specified period of inactivity. You may change the delay time to enter into each mode as required. Energy Saver Mode: Saves energy by consuming less power than when in standby mode by turning off the fuser unit after a specified time. Sleep Mode: This is the lowest power state the machine enters after the specified time without actually turning off.
		*2	15	
		3	30	
		4	60	
		5	90	
		6	120	
		7	180	
		8	240	
	SLEEP DELAY TIMER	1	15 min.	
		*2	30	
		3	60	
		4	90	
		5	180	
		6	240	
35	DAYLIGHT TIME	1	Invalid	Selecting whether the clock adjusts for Daylight Saving Time automatically. The built-in clock will advance 1 hour at 2:00 am on the first Sunday in April and fallback 1 hour at 2:00 am on the last Sunday in October.
		*2	Valid	
36	RING PATTERN (DRD) (See Note 2)	*1	Invalid	All ring patterns.
		2	Valid	Select a ring pattern for automatic answering. 1: A Standard ring pattern. 2: B Double ring pattern. 3: C Triple ring pattern (Short-Short-Long). 4: D All other triple ring pattern, except the type C described above.
37	RCV TO MEMORY		(----	Enter a 4-digit password used to print out the received document in memory by using F8-3 (RCV TO MEMORY). When F8-3 is set to On, this parameter will not be shown on the LCD display. (See page 67)
39	PIN CODE ACCESS	*1	None	Selecting the access method (Prefix or Suffix) to dial a number with PIN Code. (See page 72)
		2	Suffix	
		3	Prefix	
52	DIAGNOSTIC PASSWORD		(----	Setting the password for Remote Diagnostic Mode. Please ask your Panasonic Authorized Dealer for details.
53	SUB-ADDRESS PASSWORD		(----	Setting a 20-digit password for secured sub-address communication.

Continued on the next page.

Fax Parameters

No.	Parameter	Setting Number	Setting	Comments
58	LANGUAGE	*1	A-English	Selecting the language to be shown on the display and reports.
		2	C-French	
		3	Spanish	
61	FAX/COPY MODE	1	Fax	Setting the home position to either FAX or COPY Mode during standby. The "Remain" setting means continuation of the last mode used (either FAX or COPY Mode).
		*2	Copy	
		3	Remain	
63	PC-FAX RCV MODE	*1	Print	Selecting how to the machine will execute the receiving Fax document(s). Print: Print the received document(s). Upload & Print: Print the received document(s) and upload it's file. Upload: Upload the received document file.
		2	Upload & Print	
		3	Upload	
99	MEMORY SIZE (Flash Memory)	-	-	Displays the amount of base and optional memory installed. (Base Memory + Optional Memory)

NOTE

1. Setting number marked with an asterisk (*) indicates the factory standard setting.
2. This parameter supports an optional telephone service "Distinctive Ring Service" provided by your local telephone company. It allows up to 4 different telephone numbers to be assigned on a single telephone line with a distinctive ring for each telephone number. By selecting the appropriate ring pattern associated with the telephone number assigned for your fax machine. It can differentiate and answer the incoming call on the fax number. All other calls on the other telephone numbers will not be answered. This optional service from your local phone company is also called Custom Ringing, Distinctive Ringing, Ident-a-call, Ident-a-ring, Personalized Ringing, RingMaster, RingMate, Selective Ringing, Smart Ring or something similar. Check with your local telephone company on the availability of this service in your area.

This page is intentionally left blank.

Loading Documents

(1) On the ADF

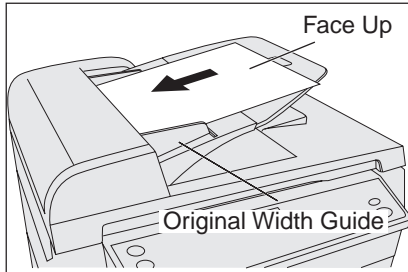

Place the original(s) Face Up on the ADF until the leading edge placed into the machine stops. Adjust the Original Width Guides to center the original(s) on the ADF.

(2) On the Platen Glass (Flatbed)

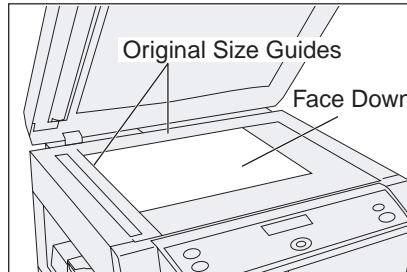

Place a book or an original Face Down on the Platen Glass, aligning it with the arrow mark on the Original Size Guides.

ADF

Original Size: Invoice, Letter, and Legal
 ADF Capacity: Up to 30 pages (20 lbs)
 Paper Weight: 13-28 lbs.
 Paper Type: Plain Paper

Platen (Original Glass)

Original Size: Invoice to Legal
 Use only dry originals
 Cover transparencies with white paper
 Gently raise and lower the Platen
 Cover or ADF

Documents not suitable for ADF

Wet
 Covered with wet ink or paste
 Wrinkled, curled or folded paper
 Too thick (Ex: cardboard or post card)
 Too thin (Ex: onionskin, airmail paper, pages from some magazines, etc.)
 Chemically processed paper (Ex: pressure-sensitive paper, carbon-coated paper, etc.)
 Coated (Ex: glossy paper, etc.)
 Made of cloth or metal
 Stapled or clipped paper

Use the Platen for these kinds of originals or make a copy first then transmit the copy instead.

Effective Scanning Size

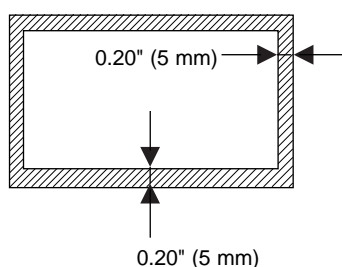

The print margin is 0.20 inch (5 mm). Letters within the dark areas (indicated by the arrows) will not be printed. Do not write letters within 0.39 inch (10 mm) area from the head or foot of the document as it may be covered by the Header and Footer information (Company Name, Date, Logo, etc.).

Basic Transmission Settings

Original/Contrast/Resolution

You can temporarily change the transmission settings either before or after you place the original on the ADF or Platen Glass.

After your original has been sent, your machine will automatically return to the preset settings.

Original

- The Original setting is useful when sending photographs or illustrations with gray tones. Your machine is preset to "AUTO". You can select either "Photograph" or "Manual" mode.

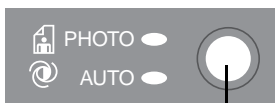

Switches with every push of the key



Contrast

- Your machine is preset to **Normal** contrast. If you wish to send an original with lighter contrast, change the setting to **Lighter**. If you wish to send an original with darker contrast, change the setting to **Darker**

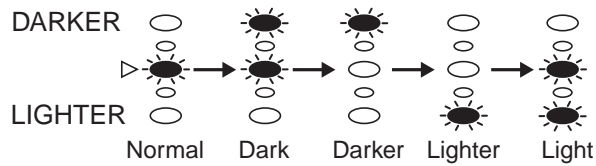
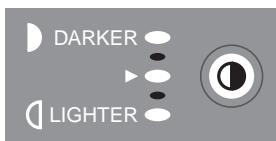

(▷ : Normal) Switches with every push of the key

Basic Transmission Settings





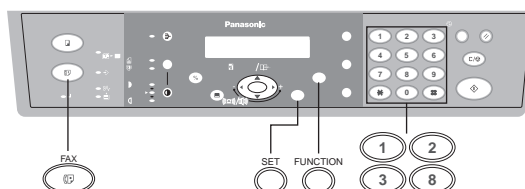



Resolution

Your machine is preset to Standard resolution, which is suitable for most documents. Use Fine or Super Fine for detailed originals. To temporarily change the Resolution, follow the steps below.



- When you set RESOLUTION = **STANDARD** : For normal original(s)
(Factory Default)
- When you set RESOLUTION = **FINE** : For detailed original(s)
Ex: Newspapers
- When you set RESOLUTION = **S-FINE** : For finer detailed original(s)

Make sure that the FAX Mode indicator is ON. If not, press **[FAX]** to select the "FAX MODE".

- 1**  
- 2** 
- 3** 
 -  for "STANDARD".
 - or
 -  for "FINE"
 - or
 -  for "S-FINE"
- 4** 

SELECT MODE (1-3)
ENTER NO. OR ∨ ^

2:RESOLUTION ?
PRESS SET TO SELECT

RESOLUTION=STANDARD
1:STD 2:FINE 3:SFINE

RESOLUTION=STANDARD
1:STD 2:FINE 3:SFINE

or

RESOLUTION=FINE
1:STD 2:FINE 3:SFINE

or

RESOLUTION=S-FINE
1:STD 2:FINE 3:SFINE

NOTE

1. To change the preset Resolution position, change the setting of Fax Parameter No. 02. (See page 35)

Basic Transmission Settings

Communication Journal (COMM. JOURNAL)

A Communication Journal lets you verify if the transmission was successful. You can select the condition to print the Communication Journal as follows.

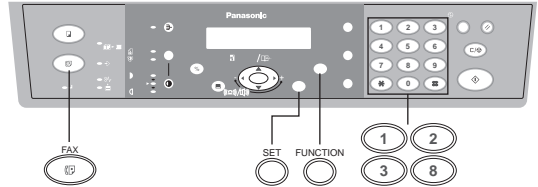

- When you set COMM. JOURNAL = **OFF**: a Communication Journal will not print.
- When you set COMM. JOURNAL = **ON** : a Communication Journal prints automatically after every communication.
- When you set COMM. JOURNAL = **INC** : a Communication Journal prints only if the communication has failed.

Make sure that the FAX Mode indicator is ON. If not, press **[FAX]** to select the "FAX MODE".

- 1** **FUNCTION** **[8]**

SELECT MODE (1-3)
ENTER NO. OR ∨ ^
- 2** **[1]** **SET**

1: COMM. JOURNAL ?
PRESS SET TO SELECT
- 3** **[1]** for "OFF".

or

[2] for "ON" (Always prints).

or

[3] for "INCOMPLETE" only.

COMM. JOURNAL=OFF
1: OFF 2: ON 3: INC

or

COMM. JOURNAL=ON
1: OFF 2: ON 3: INC

or

COMM. JOURNAL=INC
1: OFF 2: ON 3: INC
- 4** **SET**

NOTE

1. To change the preset Comm. Journal condition, change the setting of Fax Parameter No. 12. (See page 35)

Sending Documents

You can choose either Memory or Direct Transmission.

Use Memory Transmission if:

- You want to send the document to multiple stations.
- You have to retrieve the original(s) immediately.
- You want to take advantage of Dual Operation design.

Use Direct Transmission if:

- The memory is full.
- You want to send the document(s) immediately.

Use Voice Mode Transmission if:

- You want to send the document(s) after talking with the other party first.
- You want to send the document(s) after listening to a voice prompting.

Memory Transmission

Your machine quickly stores the document(s) into the machine's memory. Then, starts to dial the telephone number.

If the transmission fails, your machine will re-transmit the remaining unsuccessful page(s) automatically.

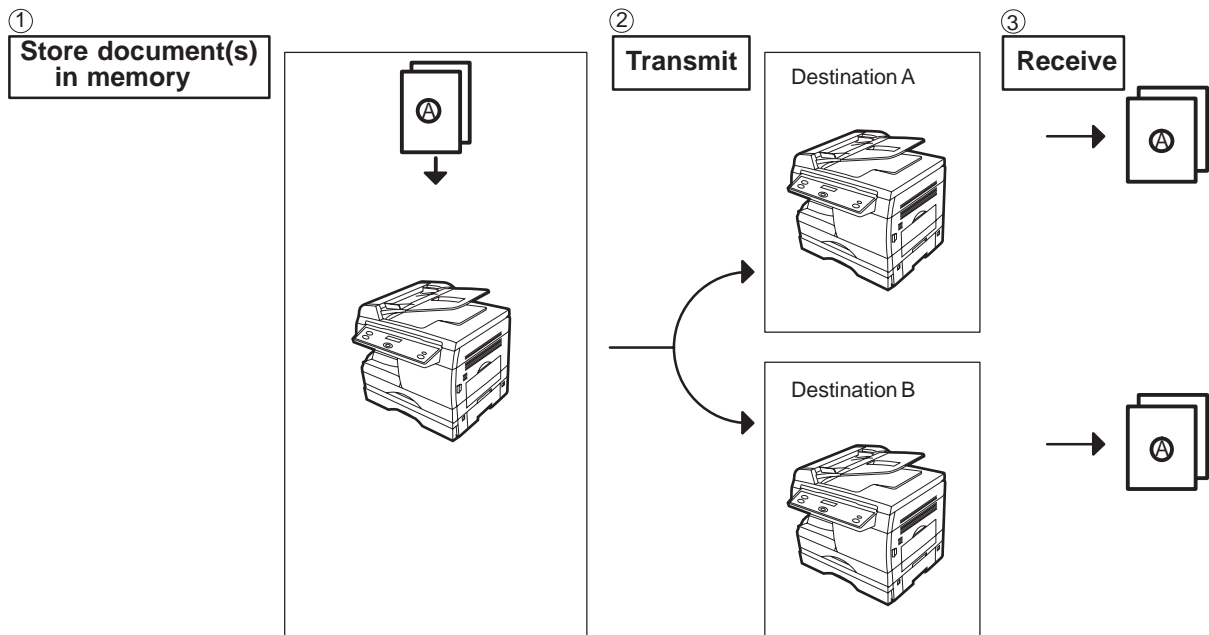

Sending Documents

NOTE

1. While storing, the File Number of the document(s) being stored is shown at the upper right corner of the display. It is also printed on the Communication Journal (COMM. JOURNAL), Transaction Journal and File List. The percentage of memory used is shown on the lower right corner of the display after each page is stored.

```
* STORE *      NO.003
                PAGES=002 10%
```

```
* STORE * COMPLETED
TOTAL PAGES=005 30%
```

2. If memory overflow occurs while storing documents, the remaining documents on the ADF will be ejected. The machine prompts you whether to transmit the successfully stored documents or to cancel the transmission. Press "1" to cancel or press "2" to transmit. See the Specifications on page 100 for the image memory capacity. If no action is taken within 10 seconds, the machine will start transmitting the stored documents.

```
OUT OF MEMORY
INFO. CODE=870
```

```
15 PAGES STORED!
DELETE? 1:YES 2:NO
```

* The percentage varies and its dependent on the type of documents you are storing, machine settings or whether an optional memory card is installed.

3. An Information Code will be displayed if the transmission has failed or no answer at the receiving side after the last automatic redial. The document stored for this transmission will be erased from the memory automatically and the information code is printed for the transmission on the Communication Journal (COMM. JOURNAL).

```
INCOMPLETE
INFO. CODE=XXX
```

4. To stop the transmission, press .
The display shows:

```
COMMUNICATION STOP?
1:YES 2:NO
```

Press "1" to stop the transmission. The document you stored will be erased automatically.

5. If you would like to print a Communication Journal (COMM. JOURNAL) after stopping a transmission, press "1" when the display shows:

```
PRINT COMM. JOURNAL?
1:YES 2:NO
```

Sending Documents

Manual Number Dialing

To dial the telephone number manually, follow the steps below.

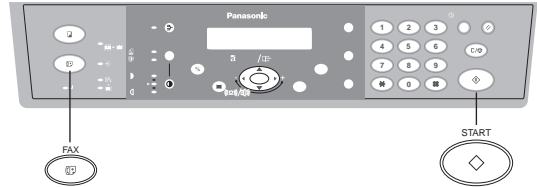

Make sure that the FAX Mode indicator is ON. If not, press **FAX** to select the "FAX MODE".

1a



Set the original(s) face up on the ADF.

ENTER STATION(S)
THEN PRESS START 00%

1b

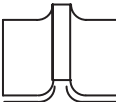

Place a book or an original face down on the Platen Glass.

OCT-12-2000 15:00
00%

2

Enter a telephone number from the keypad.

Ex: 5 5 5 1 2 3 4

TEL. NO.
5551234

3

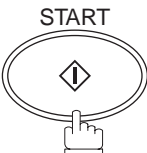

Sending Documents

ADF Scanning

- 4a** All document(s) are stored into memory with a file number. Then, the machine starts dialing the telephone number.

```
* STORE *      NO.002
      PAGES=001  05%
```

```
* DIALING *    NO.002
5551234
```

Platen Glass (Flatbed) Scanning

- 4b** When an original is placed on the Platen Glass, the display is as shown to the right.

```
ORIGINAL=LETTER
PRESS START
```

- (1) Press or to select the size of the original on the Platen Glass and press to store the document.

```
* STORE *      NO.002
      PAGES=001  05%
```

```
SCAN ANOTHER PAGE?
1: YES 2: NO
```

- (2) To store another original into memory, press "1" to select "YES".
If there are no other originals, press "2" to select "NO".
(See Note 3)
If "YES" is selected, set the size of the original and press .

If "NO" is selected, the machine starts to dial the telephone number.

```
* DIALING *    NO.002
5551234
```

NOTE

1. If you need a special access number to get an outside line, dial it first then press to enter a pause (represented by a "-") before dialing the full number.
Ex: 9 PAUSE 5551234
2. If you are using Pulse dialing and you wish to change to Tone dialing in the middle of dialing, press (represented by a "/").
The dialing mode will be changed from Pulse to Tone after dialing the digit "/".
Ex: 9 PAUSE TONE 5551234
3. If no action is taken within 60 seconds, the machine will start dialing.

Sending Documents

Directory Search Dialing

Directory Search Dialing allows you to dial a full telephone number by searching the station's name.

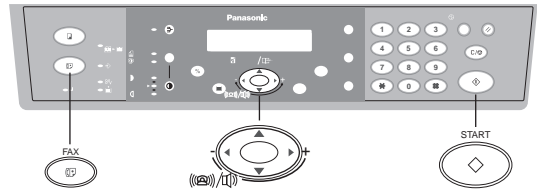

Make sure that the FAX Mode indicator is ON. If not, press **FAX** to select the "FAX MODE".

1a



Set the original(s) face up on the ADF.

ENTER STATION(S)
THEN PRESS START 00%

1b

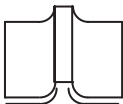

Place a book or an original face down on the Platen Glass.

OCT-12-2000 15:00
00%

2

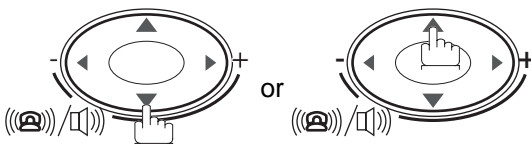

repeatedly until the display shows the station name you want to send to.

PANASONIC
5551234

3

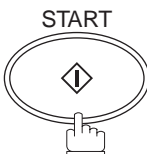

Sending Documents

ADF Scanning

- 4a** All document(s) are stored into memory with a file number. Then, the machine starts dialing the telephone number.

```
* STORE *      NO.002
      PAGES=001  05%
```

```
* DIALING *    NO.002
PANASONIC
```

Platen Glass (Flatbed) Scanning

- 4b** When an original is placed on the Platen Glass, the display is as shown to the right.

```
ORIGINAL=LETTER
PRESS START
```

- (1) Press or to select the size of the original on the Platen Glass and press to store the document.

```
*STORE*      NO.002
      PAGES=001  05%
```

```
SCAN ANOTHER PAGE?
1:YES 2:NO
```

- (2) To store another original into memory, press "1" to select "YES".
If there are no other originals, press "2" to select "NO".
(See Note 1)
If "YES" is selected, set the size of the original and press .

If "NO" is selected, the machine starts to dial the telephone number.

```
* DIALING *    NO.002
PANASONIC
```

NOTE

1. If no action is taken within 60 seconds, the machine will start dialing.

Sending Documents

Multi-Station Transmission (Broadcasting)

If you have to send the same document(s) to multiple stations, you can save time in feeding the document(s) by using memory transmission. That is, you can store the document(s) into memory and then send it to the station(s) automatically. (See Note 1)

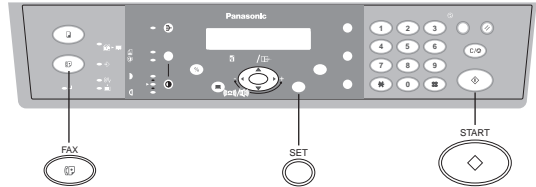

Make sure that the FAX Mode indicator is ON. If not, press **FAX** to select the "FAX MODE".

1a



Set the original(s) face up on the ADF.

ENTER STATION(S)
THEN PRESS START 00%

1b



Place a book or an original face down on the Platen Glass.

OCT-12-2000 15:00
00%

2

Dial by any combination of the following methods (Up to 10 stations):

- Manual Number Dialing, press **SET** after each station is entered
- Directory Search Dialing, press **SET** after each station is entered
(For details, see pages 45 to 48.)

Ex: (5) (5) (5) (1) (2) (3) (4)



(5) (5) (5) (3) (4) (5) (6)

If you want to confirm the number of stations you have entered, press **◀** or **▶**.

TEL. NO.
5551234

TEL. NO.
5553456

2 STN(S) ARE SET
ADD MORE OR START

3

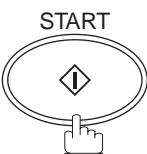

NOTE

1. The Fax Parameter No. 05 (MEMORY) position must be in the factory default setting (ON). (See page 35)

Sending Documents

ADF Scanning

- 4a** All document(s) are stored into memory with a file number. Then, the machine starts dialing the telephone numbers in sequence.

```
* STORE *      NO.001
      PAGES=001  01%
```

```
* STORE * COMPLETED
TOTAL PAGE=005  25%
```

```
* DIALING *    NO.001
5551234
```

Platen Glass (Flatbed) Scanning

- 4b** When an original is placed on the Platen Glass, the display is as shown to the right

```
ORIGINAL=LETTER
PRESS START
```

- (1) Press or to select the size of the original on the Platen Glass and press to store the document.

```
* STORE *      NO.002
      PAGES=001
```

```
SCAN ANOTHER PAGE?
1: YES 2: NO
```

- (2) To store another original into memory, press "1" to select "YES".
If there are no other originals, press "2" to select "NO".
(See Note 2)
If "YES" is selected, set the size of the original and press .

If "NO" is selected, the machine starts to dial the telephone number.

```
* DIALING *    NO.002
5551234
```

NOTE

1. You can review the stations you entered in step 2 before storing your document(s) into memory by pressing or . Press to clear an entered station or group shown on the display if needed.
2. If no action is taken within 60 seconds, the machine will start dialing.

Sending Documents

Direct Transmission

If your machine's memory is full or you wish to send the document immediately, use Direct Transmission.
(To use Direct Transmission, you must change the Fax Parameter No. 05 (MEMORY) setting to "OFF" in advance.
(See page 35 and Note 1 below)

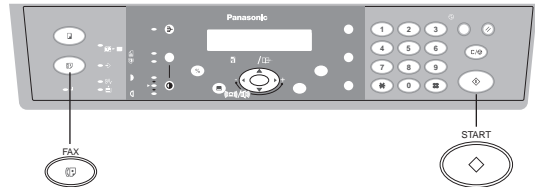

Manual Number Dialing (Direct Transmission)

To dial the telephone number manually, follow the steps below.

Make sure that the FAX Mode indicator is ON. If not, press **FAX** to select the "FAX MODE".

1a



Set the original(s) face up on the ADF.

ENTER STATION

1b

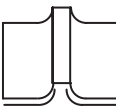

Place a book or an original face down on the Platen Glass.

SEP-12-2000 15:00
00%

2

Enter a telephone number from the keypad.

Ex: 5 5 5 1 2 3 4

PRESS START TO DIAL
5551234

3

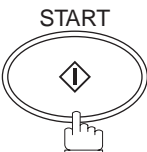

Your machine starts to dial the telephone number.

NOTE

1. After the Direct Transmission is completed, reset the Fax Parameter No. 05 (MEMORY) setting to "ON" (factory default position).

Sending Documents



ADF Scanning

4a The machine starts to dial the telephone number.

```
* DIALING *  
5551234
```

Platen Glass (Flatbed) Scanning

4b When an original is placed on the Platen Glass, the display is as shown to the right.

Press  or  to select the size of the original on the Platen Glass and press **START** to start dialing.

```
ORIGINAL=LETTER  
PRESS START
```

NOTE

1. If you need a special access number to get an outside line, dial it first then press **REDIAL/PAUSE** to enter a pause (represented by a "-") before dialing the full number.

Ex: 9 PAUSE 5551234

2. If you are using Pulse dialing and you wish to change to Tone dialing in the middle of dialing, press **TONE** (represented by a "/").

The dialing mode will be changed from Pulse to Tone after dialing the digit "/".

Ex: 9 PAUSE TONE 5551234

3. To stop the transmission, press **CLEAR/STOP**.

The display shows:

```
COMMUNICATION STOP?  
1: YES 2: NO
```

Press "1" to stop the transmission. The Communication Journal will not print regardless of the printout mode setting of the Communication Journal.

Sending Documents

Directory Search Dialing (Direct Transmission)

Directory Search Dialing allows you to dial a full telephone number by searching the station's name.
 (To use Direct Transmission, you must change the Fax Parameter No. 05 (MEMORY) setting to "OFF" in advance.
 (See page 35 and Note 1 below)

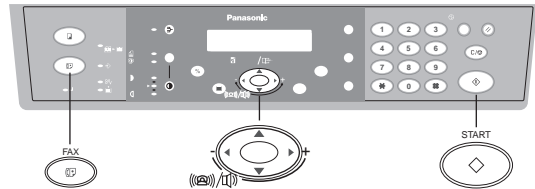

Make sure that the FAX Mode indicator is ON. If not, press **FAX** to select the "FAX MODE".

1a  Set the original(s) face up on the ADF.

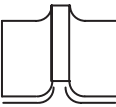

1b  Place a book or an original face down on the Platen Glass.

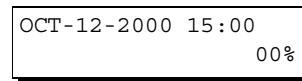

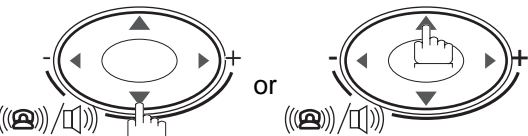
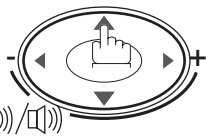
2  or  repeatedly until the display shows the station name you want to send to.

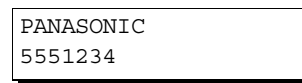

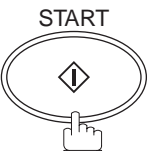
3  The full number (e.g. 5551234) will be dialed.

ADF Scanning

4a The machine starts to dial the telephone number.

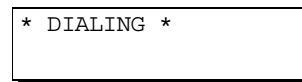

Platen Glass (Flatbed) Scanning

4b When an original is placed on the Platen Glass, the display is as shown to the right.
 Press **▼** or **▲** to select the size of the original on the Platen Glass and press **START** to start dialing.

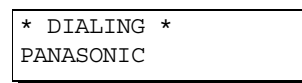
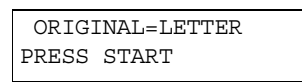

NOTE

1. After the Direct Transmission is completed, reset the Fax Parameter No. 05 (MEMORY) setting to "ON" (factory default position).

Sending Documents

Voice Mode Transmission

If you wish to send the document after talking with other party first, use Voice Mode Transmission. Your machine requires an optional fax handset or an external telephone.

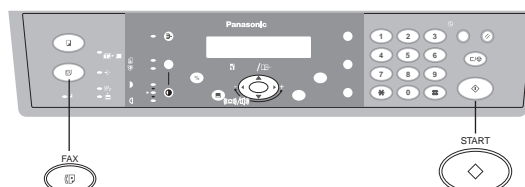

Off-Hook Dialing

For Off-Hook Dialing, follow the steps below.

Make sure that the FAX Mode indicator is ON. If not, press **FAX** to select the "FAX MODE".

1



Set the original(s) face up on the ADF.

ENTER STATION(S)
THEN PRESS START 00%

2

Lift the fax handset or the external telephone and dial the telephone number from the keypad or use Directory Search Dialing.

* PHONE OFF HOOK *
00%

Ex: ⑤ ⑤ ⑤ ① ② ③ ④

* DIALING *
5551234 ■

3

When you hear the voice of the other party, tell the other party to prepare to receive a document(s).

ON LINE * XMT *

Then, when you hear a beep,

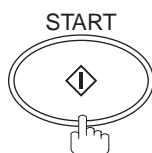

and hang up the handset.

NOTE

1. To stop the transmission, press **CLEAR/STOP** .
The display shows:

COMMUNICATION STOP?
1: YES 2: NO

Press "1" to stop the transmission. The Communication Journal will not print regardless of the printout mode setting of the Communication Journal.

2. Voice Mode Transmission is only available from the ADF. If you need to send pages from a Book or originals that can not be fed through the ADF, make a copy on the Platen Glass first then use the ADF for Voice Mode Transmission.

Sending Documents

On-Hook Dialing

For On-Hook Dialing, follow the steps below.

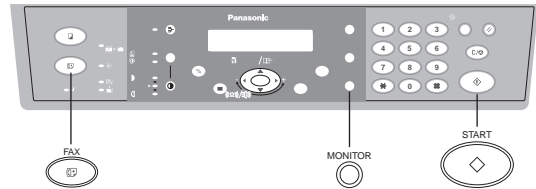

Make sure that the FAX Mode indicator is ON. If not, press **FAX** to select the "FAX MODE".

1



Set the original(s) face up on the ADF.

ENTER STATION(S)
THEN PRESS START 00%

2



You will hear dial tone through the monitor speaker.

* MONITOR *

3

Dial the telephone number from the keypad or use Directory Search Dialing.

* DIALING *
5551234 ■

Ex: 5 5 5 1 2 3 4

4

When you hear a beep,

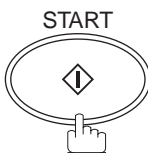

ON LINE * XMT *

NOTE

1. If you need a special access number to get an outside line, dial it first then press **REDIAL/PAUSE** to enter a pause (represented by a "-") before dialing the full number.
Ex: 9 PAUSE 5551234
2. If you are using Pulse dialing and you wish to change to Tone dialing in the middle of dialing, press **TONE** (represented by a "/").
The dialing mode will be changed from Pulse to Tone after dialing the digit "/".
Ex: 9 PAUSE TONE 5551234
3. On-Hook Dialing is only available from the ADF. If you need to send pages from a Book or originals that can not be fed through the ADF, make a copy on the Platen Glass first then use the ADF for Voice Mode Transmission.

Sending Documents

Transmission Reservation

You can reserve the next transmission into memory (up to 5 different files) while sending a document from memory or receiving a document.

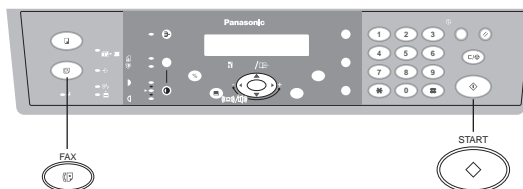

Memory Transmission Reservation (Multi-tasking)

If your machine is on-line busy transmitting from memory, receiving or printing received documents, you can reserve a transmission by the following procedure.

Make sure that the FAX Mode indicator is ON. If not, press **[FAX]** to select the "FAX MODE".

- 1** Your machine is on-line, the ON LINE lamp is blinking or printing received documents.

```
ON LINE * MEM.XMT *
ID:(Identification)
```

```
ON LINE * RCV *
ID:(Identification)
```

```
ON LINE
PC MODE
```

```
* PRINTING *
MEMORY RCV'D DOC
```

```
ENTER STATION(S)
THEN PRESS START 00%
```

- 2**  Set the original(s) face up on the ADF.

- 3** Dial by any combination of the following methods (up to 10 stations):

- Manual Number Dialing, press **[SET]** after each station is entered
- Directory Search Dialing, press **[SET]** after each station is entered

(For details, see pages 45 to 48.)

Ex: (5) (5) (5) (1) (2) (3) (4)

```
TEL. NO.
5551234
```

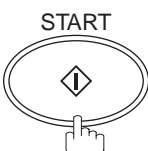
- 4** 

Your machine will store the original(s) into memory.

```
* STORE *      NO.005
      PAGES=001  01%
```

```
* STORE * COMPLETED
TOTAL PAGES=005  25%
```

NOTE

1. To cancel the memory transmission reservation, see page 66.

Sending Documents

Redialing

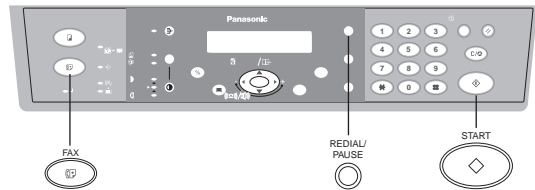

Automatic Redialing

If a busy line is detected, the machine will redial the number up to 5 times at 3 minutes interval. However, if a busy line is not detected, the machine will redial only one time. During that time, a message will appear as shown to the right.

A file number is shown in the upper right hand corner of the display if it is a memory transmission file.

WAIT TO DIAL NO.001
(Telephone number)

Manual Redialing

You can also redial the last dialed number manually by pressing **REDIAL/PAUSE** key.

To redial the last dialed number through memory

Make sure that the FAX Mode indicator is ON. If not, press **FAX** to select the "FAX MODE".

1



Set the original(s) face up on the ADF.

ENTER STATION(S)
THEN PRESS START 00%

2

REDIAL/
PAUSE



TEL. NO.
5551234

3

START

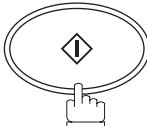

* STORE * NO.002
PAGES=001 01%

* DIALING * NO.002
5551234

The document(s) are stored into memory with a file number. Then the machine dials the last dialed number.

NOTE

1. While the unit is displaying "WAIT TO DIAL", you can press **REDIAL/PAUSE** to start redialing immediately.

Receiving Documents

Reception

Your machine is provided with both automatic and manual reception modes. The selection of either reception mode is made with Fax Parameter No. 17 (RECEIVE MODE).

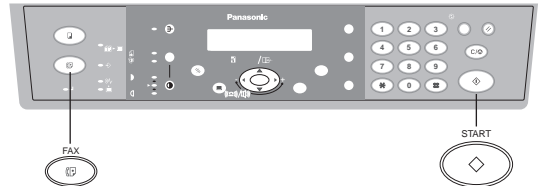

Automatic Reception

Your machine will receive documents automatically if the Fax Parameter No. 17 (RECEIVE MODE) is set to "Auto". (See page 35)

Manual Reception

You may wish to receive documents manually if you use the telephone line in your office primarily as a personal telephone and occasionally for your machine.

To receive documents manually, change the Fax Parameter No. 17 (RECEIVE MODE) to "Manual" (See page 35) and the following message will be shown on the display.

OCT-12-2000 15:00
MANUAL RCV 00%

To receive documents manually

Make sure that the FAX Mode indicator is ON. If not, press **[FAX]** to select the "FAX MODE".

- 1** When the telephone rings, lift the handset. (See Note 1)
If you hear a beep, the sound tells you that someone wants to send you a document(s).
- 2** Remove any original(s) from the ADF.

* PHONE OFF HOOK *

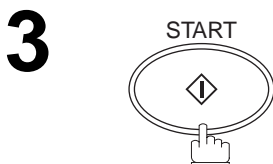

ON LINE * RCV *

- 4** Your machine starts receiving the document(s).
Hang up the telephone.

NOTE

1. Your machine requires an optional handset or an external telephone connected to the TEL jack on the rear of the machine.

Receiving Documents

Print Reduction

This machine can use Letter or Legal size plain paper for recording. Sometimes, oversized documents sent to you by the other parties cannot be printed within a single page. When this occurs, the document will be divided into separate pages.

This machine is equipped with a Print Reduction function to solve this problem. You may select the most appropriate setting from the selections described below.

1. Automatic Reduction

Each received document is first stored in memory. Based on the document length, your machine will automatically calculate the suitable reduction ratio (70% to 100%) to print the entire document on a single page. If the received document is extremely long (over 39% longer than the recording paper), the document will be divided into separate pages and print without reduction.

2. Fixed Reduction

You can pre-determine the reduction ratio from 70% to 100% in 1% steps. The received document(s) will be reduced to the fixed ratio regardless of size.

Selecting the Print Reduction Mode

Set Fax Parameters as shown below. (See page 35)

1. To set the Automatic Reduction mode.

(1) No. 24 Print Reduction set to "Auto".

2. To set the Fixed Reduction mode.

(1) No. 24 Print Reduction set to "Fixed".

(2) No. 25 Reduction Ratio set to any number between 70% through 100%. (See Note 1)

Ex: A4 to A4 - 96%

A4 to Letter - 90%

Letter to Letter - 96%

Legal to Letter - 75%

NOTE

1. If the sending side is set to print the header on the outside of the copy area, more reduction ratio will be required.

Receiving Documents

Receiving Oversize Documents

If the received document is extremely long (over 39% longer than the recording paper), the document will be divided into separate pages. When printing on separate pages, the bottom 0.4 in (10 mm) of first page will be overlapped on top of the next page.

Transmitted Document

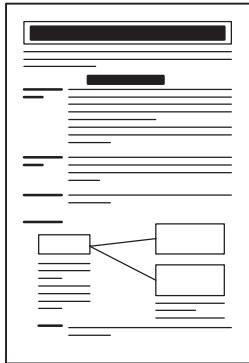

Received Document

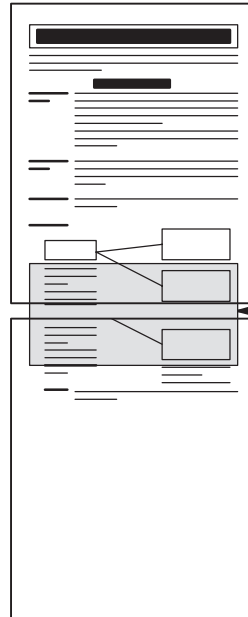
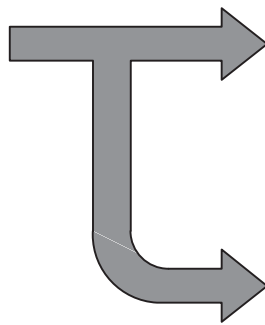

Overlap print.
0.4 in (10 mm)

The receiving document is divided into two sheets with overlap printing.

NOTE

1. If the reduction method is set to the Automatic Reduction mode, the document prints with no reduction when printing separate pages. If the reduction method is set to Fixed Reduction mode, the printed document is reduced by the ratio set in Fax Parameter No. 25.

Receiving Documents

Substitute Memory Reception

If the recording paper runs out or jams or if the toner runs out during reception, the machine automatically starts receiving documents into its image data memory. Stored documents are printed automatically after replacing the recording paper or the toner cartridge. (See Note 1 and 2)

- 1** When the machine finishes the memory reception and there is no recording paper or toner, ADD PAPER or ADD TONER indicator appears on the display.

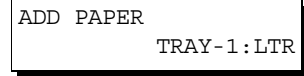

ADD PAPER
TRAY-1 : LTR



ADD TONER

- 2** Install the recording paper or replace the toner cartridge.
The machine will automatically start printing the document(s) stored in the memory.

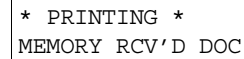

* PRINTING *
MEMORY RCV'D DOC

NOTE

- If the memory overflows, the machine will stop receiving and release the communication line. The document(s) stored in the memory up to that moment will be printed.*
- If you wish to turn off the substitute reception function, change the setting of Fax Parameter No. 22 to "Invalid". (See page 35)*

This page is intentionally left blank.

Polling

Setting the Polling Password

Polling means calling other station(s) to retrieve document(s). The other station must know in advance that you will call and must have the document(s) set on the ADF or stored in the memory. You may need to set a polling password, shared by the other station, to ensure security.

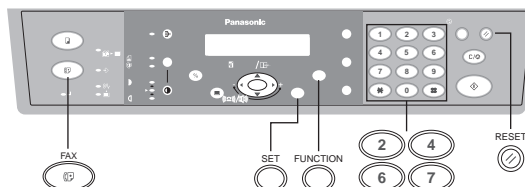



If the polling password does not match with the polled station, your polling request will be refused automatically.

To set the polling password, follow the steps below.

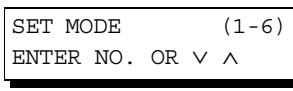
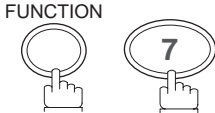
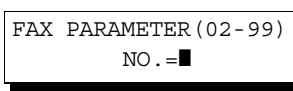
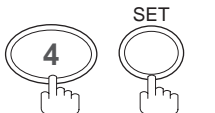
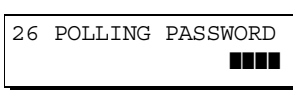
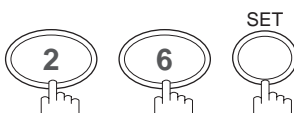
Make sure that the FAX Mode indicator is ON. If not, press **FAX** to select the "FAX MODE".

- 
- 
- 
- Enter a 4-digit polling password.

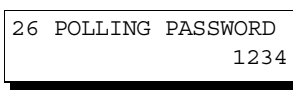
Ex: (1) (2) (3) (4)

- 

NOTE

1. Polling might not function with all fax machines. We suggest you attempt a trial polling before you actually poll important documents.
2. If a password is not set in the polled station, you may poll the other station even though your machine has a password.

Polling

To Poll Documents from Another Station

The following procedure lets you poll a document from one or multiple stations. Be sure to set the polling password before polling. (See page 63)

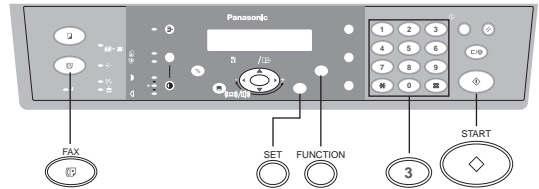

Make sure that the FAX Mode indicator is ON. If not, press **[FAX]** to select the "FAX MODE".

1

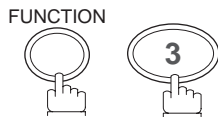

03 : POLLING ?
PRESS SET TO SELECT

2



POLLING
PASSWORD=1234

3

Enter a 4-digit polling password. (See Note 1)

Ex: ① ① ① ①

POLLING
PASSWORD=1111

4



ENTER STATION(S)
THEN PRESS START

Polling

5

Dial by any combination of the following methods (up to 10 stations):

- Manual Number Dialing, press **SET** after each station is entered (For details, see pages 45 and 46)
- Directory Search Dialing, press **SET** after each station is entered (For details, see pages 47 to 48.)

Ex: ⑤ ⑤ ⑤ ① ② ③ ④

TEL. NO.
5551234

6

Confirm the selected station(s) (See Note 2)

7

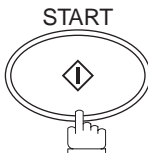

* STORE * NO.001

NOTE

1. If you have set the polling password in Fax Parameter No. 26, the password will appear on the display. You can still change the password temporarily by overwriting it with a new one.
2. You can review the entered stations in step 5 by pressing ◀ or ▶ keys, press **CLEAR/STOP** to erase the displayed station or group as needed.

Edit File Mode

Deleting a File

To delete the reserved file(s) in memory, follow the steps below.

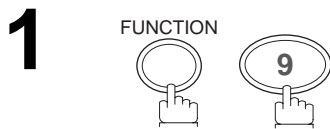
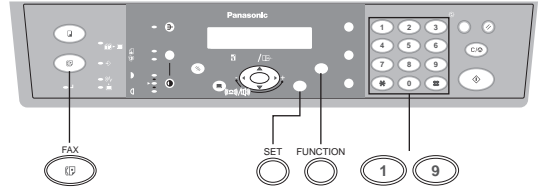

9:DELETE FILE ?
PRESS SET TO SELECT



ENTER FILE NO.OR ∨ ∧
FILE NO.=■■■

3 Enter the file number or use ▼ or ▲ to select the file that you want to delete.

Ex: 0 0 1 (See Note 2)

ENTER FILE NO.OR ∨ ∧
FILE NO.=001



DELETE FILE NO.001?
1:YES 2:NO

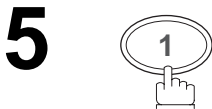

Enter the next file number you want to delete or press
CLEAR/STOP to return to standby.

* DELETING *
FILE NO.=001

ENTER FILE NO.OR ∨ ∧
FILE NO.=■■■

NOTE

- Your machine cannot delete the file while it is being sent.
- Enter * * * as the file number and press SET to delete all files (except the file in progress). The following message is shown on the display.

DELETE ALL FILES?
1:YES 2:NO

Press "1" to delete all files.

Receive To Memory

Setting RCV To Memory Password/Setting RCV to Memory

This feature is used to secure all received documents by storing them into the memory. To print the document(s) received in memory, the authorized operator must enter the correct password.

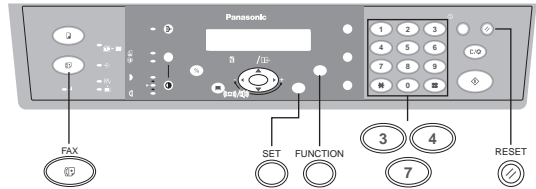

Setting the RCV To Memory Password

Make sure that the FAX Mode indicator is ON. If not, press **[FAX]** to select the "FAX MODE".

- 1**

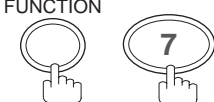

SET MODE (1-6)
 ENTER NO. OR ∨ ^
- 2**

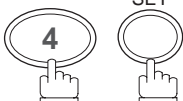

FAX PARAMETER (02-99)
 NO. =■
- 3**



37 RCV TO MEMORY ■■■■
- 4**

Enter a 4-digit RCV to Memory Password.
Ex: ① ② ③ ④

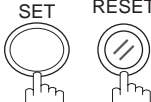

37 RCV TO MEMORY
 1234
- 5**



Receive To Memory

Setting RCV To Memory

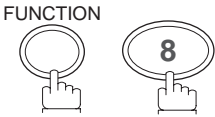
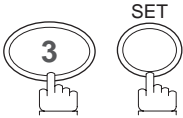
Make sure that the FAX Mode indicator is ON. If not, press **FAX** to select the "FAX MODE".

1		<pre>SELECT MODE (1-3) ENTER NO. OR ∨ ∧</pre>
2		<pre>RCV TO MEMORY=OFF 1:OFF 2:ON 3:PRINT</pre>
3		<pre>RCV TO MEMORY=ON 1:OFF 2:ON 3:PRINT</pre>
4		<pre>OCT-12-2000 15:00 < RCV TO MEMORY ></pre>

NOTE

1. When the memory overflows, the machine will stop receiving and release the line. The machine will not answer the next incoming call until there is space available in memory.
2. We recommend that optional flash memory card is installed when this function is used. See page 100 on Image Memory Capacity.

Receive To Memory

Printing Out Documents

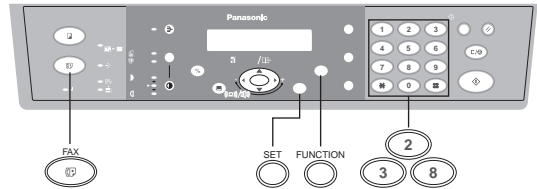

After receiving document(s) with the Receive To Memory feature, the following message will appear on the display.

MESSAGE IN MEMORY
< RCV TO MEMORY >

To print the document(s), follow the steps below. (See Note 1 and 2)

Make sure that the FAX Mode indicator is ON. If not, press **FAX** to select the "FAX MODE".

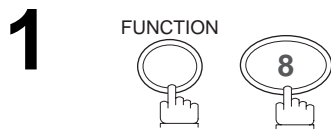

SELECT MODE (1-3)
ENTER NO. OR ∨ ^



RCV TO MEMORY=ON
1:OFF 2:ON 3:PRINT



RCV TO MEMORY=PRINT
1:OFF 2:ON 3:PRINT



INPUT PASSWORD ■■■■

Receive To Memory

5 Enter the password to print the document(s).
(See Note 1)

INPUT PASSWORD
1234

Ex: ① ② ③ ④

6



Machine will start to print the document(s).

* PRINTING *
MEMORY RCV'D DOC

NOTE

1. If the password has not been set, your machine will not prompt you to enter the password. The document(s) will be printed immediately after pressing in step 4.
2. Once the RCV TO MEMORY feature is set to "On", the password cannot be changed (Fax Parameter No. 37 will not be shown on the LCD display). If you wish to change the password, set RCV TO MEMORY feature to "Off" first (Password is required). Then change the password. (See page 67)

Distinctive Ring Detector (DRD)

Your machine has a special feature in conjunction with an optional service provided by many local telephone companies. It can distinguish up to 4 telephone numbers with a corresponding ring pattern identifying each number. "DRD" lets you provide multiple phone numbers, one for your fax, business or personal use with only one single phone line.

Please check with your local telephone company on the availability of this service in your area.

Your machine can be programmed to respond to only 1 of the 4 distinctive ring patterns. To select the corresponding ring pattern for your fax number, refer to the Fax Parameter Table on page 36.

The following table shows a typical example with 4 telephone numbers on a single phone line.

Telephone No.	Usage	Distinctive Ring Sound	Ring Pattern
555-1111	Business	Riiing.....Riiing.....	Type A, Standard Ring
555-2222	Fax	Ring...Ring.....Ring...Ring.....	Type B, Double Ring
555-3333	Personal	Ring...Ring...Riiing.....Ring...Ring...Riiing.....	Type C, Triple Ring (Short-Short-Long)
555-4444	Teenager	Ring...Riiing...Ring.....Ring...Riiing...Ring.....	Type D, Triple Ring (All other than type C)

(see Note 1)

The following illustration shows a typical set up, with your machine set to detect Type B (double ring) ring pattern.

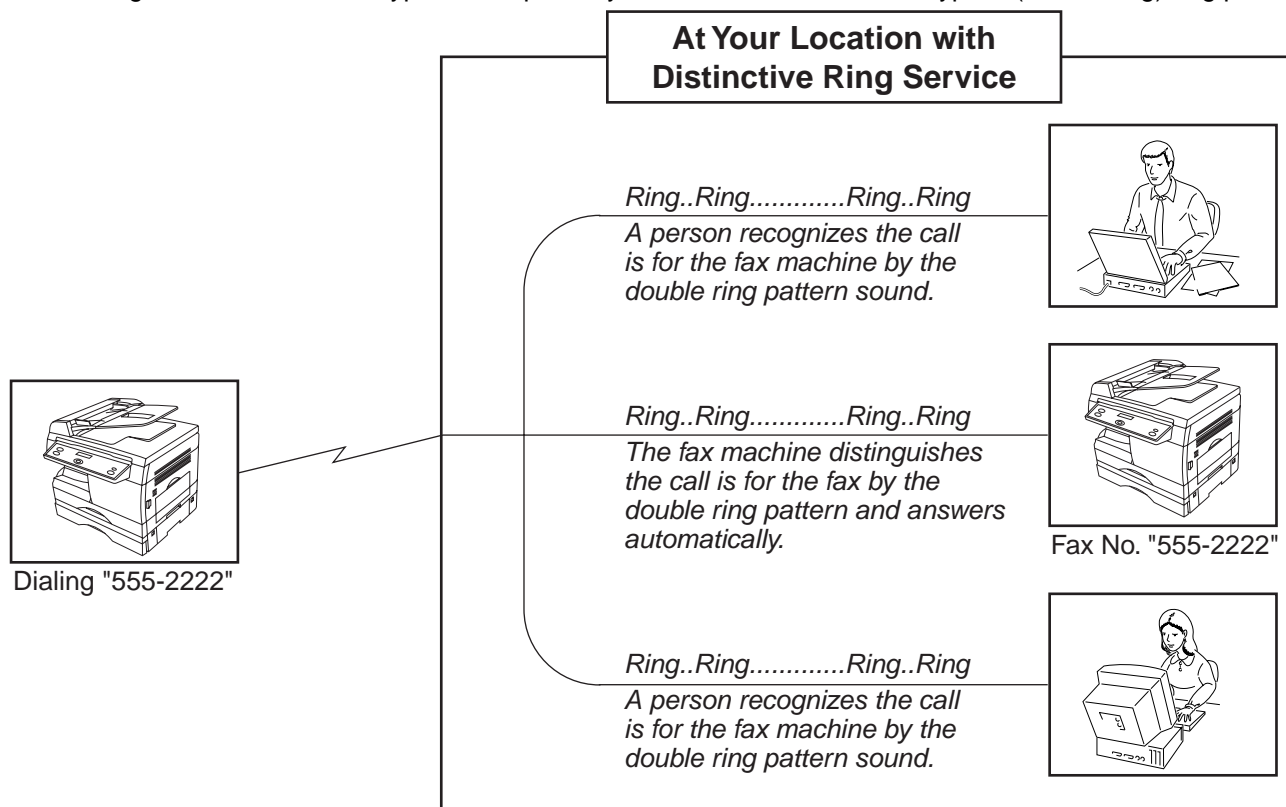

NOTE

1. "Riiing" means a long ringing sound and "Ring" means a short ringing sound.

PIN Code Access

If your PBX requires a PIN (Personal Identification Number) code to get an outside line, your machine can be set to prompt the user to enter a PIN code before any dialing.

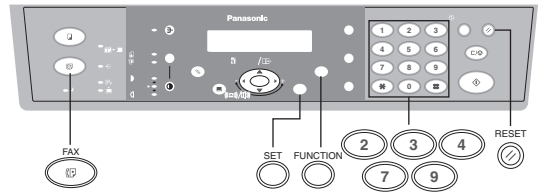

Selecting the Access Method (Prefix or Suffix)

Make sure that the FAX Mode indicator is ON. If not, press **FAX** to select the "FAX MODE".

1

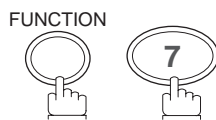

```
SET MODE      (1-6)
ENTER NO. OR v ^
```

2

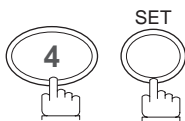

```
FAX PARAMETER (02-99)
NO. =■
```

3

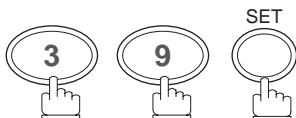

```
39 PIN CODE ACCESS
1:NONE
```

4



for suffix code.

or



for prefix code.

```
39 PIN CODE ACCESS
2:SUFFIX
```

```
39 PIN CODE ACCESS
3:PREFIX
```

5

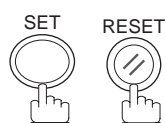

PIN Code Access

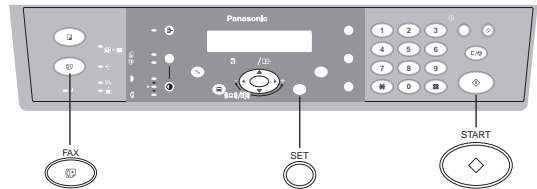

Dialing with a PIN Code

Make sure that the FAX Mode indicator is ON. If not, press **FAX** to select the "FAX MODE".

1a  Set the original(s) face up on the ADF.

ENTER STATION(S)
THEN PRESS START 00%

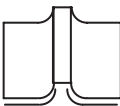
1b  Place a book or an original face down on the Platen Glass.

OCT-12-2000 15:00
00%

2 Dial by any combination of the following methods (up to 10 stations):

- Manual Number Dialing, press **SET** after each station is entered
- Directory Search Dialing, press **SET** after each station is entered

(For details, see pages 45 to 48.)

Ex: ⑤ ⑤ ⑤ ① ② ③ ④



⑤ ⑤ ⑤ ③ ④ ⑤ ⑥

If you want to confirm the number of stations you have entered, press **◀** or **▶**.

TEL. NO.
5551234

TEL. NO.
5553456

2 STN(S) ARE SET
ADD MORE OR START

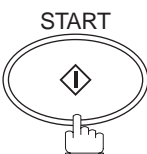
3 

ENTER PIN CODE
■

4 Enter the PIN code.

PIN Code Access

5

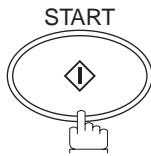

ADF Scanning

6a

All document(s) are stored into memory with a file number. Then the machine starts dialing the telephone numbers in sequence.

```
* STORE *      NO.001
      PAGES=001  01%
```

```
* STORE * COMPLETED
TOTAL PAGE=005  25%
```

```
* DIALING *    NO.001
(Station name)
```

Platen Glass (Flatbed) Scanning

6b

When an original is placed on the Platen Glass, the display is as shown to the right.

```
ORIGINAL=LETTER
PRESS START
```

- (1) Press or to select the size of the original on the Platen Glass and press to store the document.

```
* STORE *      NO.002
      PAGES=001  05%
```

```
SCAN ANOTHER PAGE?
1: YES 2: NO
```

- (2) To store another original into memory, press "1" to select "YES".
If there are no other originals, press "2" to select "NO".
(See Note 3)
If "YES" is selected, set the size of the original and press .

If "NO" is selected, the machine starts to dial the telephone number.

```
* DIALING *    NO.002
5551234
```

NOTE

1. The PIN code is shown as "■" on the display when dialing the number.
2. This feature is not available when dialing a number by using Off-Hook or On-Hook Direct Dialing mode.
3. If no action is taken within 60 seconds, the machine will start dialing.

Sub-Addressing

General Description

The Sub-Addressing function allows you to further routing or forwarding or relaying of document(s) to the desired recipient(s) when used in combination with the Networking version of LaserFax software. This function conforms to the ITU-T recommendation for T. Routing-Facsimile Routing utilizing the Sub-Address.

Example of a Network

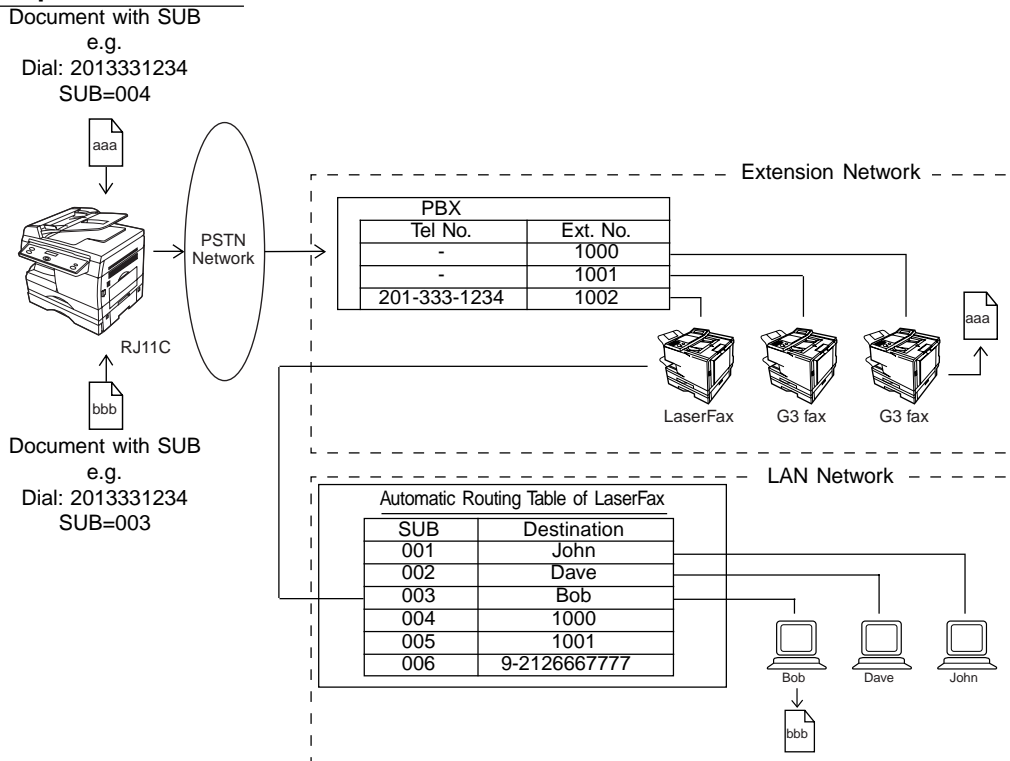

Compatibility with Other Machines

- Sub-Addressing Transmission: DF-1100/DP-135FP/2500/DX-1000/2000/FP-D250F/D350F/UF-332/333/342/344/550/560/585/595/770/788/880/885/895 (see Note 2)
- Sub-Addressing Reception: DX-1000/2000,DF-1100/UF-342/344/550/560/585/595/770/788/880 with PC Interface using the Networking version of LaserFax software.

Sub-Addressing Transmission Methods

You can send a document with Sub-address information to the desired recipient by the following methods.

- By registering the Sub-address information into the Directory Search Dialing.
- By specifying the Sub-address information in the Manual Number Dialing Mode.

Setting of Routing, Forwarding or Relaying

You can customize the Automatic Routing to any combination of LAN (Local Area Network), PSTN (Public Switched Telephone Network) or PBX Extension with LaserFax Routing Table (please refer to the LaserFax User Manual).

NOTE

1. LaserFax is a registered trademark of Wordcraft International Ltd.
2. UF-788 with PC Interface Option or the Option ROM installed.

Sub-Addressing

Setting the Sub-Address into the Directory Search Dialing Numbers

Make sure that the FAX Mode indicator is ON. If not, press **[FAX]** to select the "FAX MODE".

1

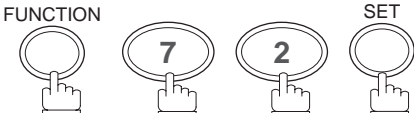

DIR. STN. DIAL (1-3)
ENTER NO. OR v ^

2



1:ADD STATION
PRESS SET TO SELECT

3



REGISTERED ENTRIES
STN(S) : 0 GROUP : 0

↓3.0 sec. later

ENTER NAME
■

4 Enter the station name.

5



ENTER TEL. NO.
■

Enter the telephone number, press **[FLASH/SUB-ADDR]** then enter the Sub-Address. (Up to 20 digits)
(Up to 36 digits including telephone number, pauses, spaces, FLASH and Sub-Address)

Ex: Telephone number = 5551234, Sub-Address = 2762
Enter as: (5) (5) (5) (1) (2) (3) (4)
[FLASH/SUB-ADDR] (2) (7) (6) (2)

6

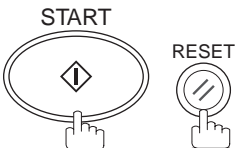

ENTER TEL. NO.
5551234s2762■

NOTE

1. **[FLASH/SUB-ADDR]** separates the Sub-Address from the Telephone number and is indicated by an "s" in the display.

Sub-Addressing

Sending a FAX with Sub-Address

Using Directory Search Dialing

The operation is the same as for normal dialing

Make sure that the FAX Mode indicator is ON. If not, press **FAX** to select the "FAX MODE".

1a



Set document(s) face up on the ADF.

ENTER STATION(S)
THEN PRESS START 00%

1b

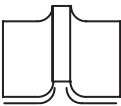

Place a book or an original face down on the Platen Glass.

OCT-12-2000 15:00
00%

2

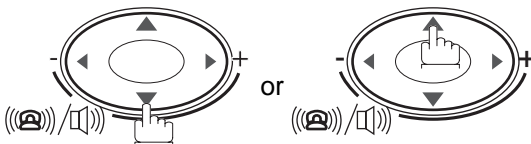

repeatedly until the display shows the station name you want to send to.

PANASONIC
5551234s2762

3

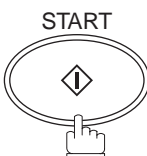

The document(s) are stored into memory and your machine starts to dial the number of the station and sends the document(s) with Sub-Addressing information.

* STORE * NO. 001
PAGES=001 01%

Sub-Addressing

Using Manual Number Dialing

Use **FLASH/SUB-ADDR** to separate the Telephone number and the Sub-Address

Make sure that the FAX Mode indicator is ON. If not, press **FAX** to select the "FAX MODE".

1a



Set the original(s) face up on the ADF.

ENTER STATION(S)
THEN PRESS START 00%

1b



Place a book or an original face down on the Platen Glass.

OCT-12-2000 15:00
00%

2

Enter the telephone number, press **FLASH/SUB-ADDR** then enter the Sub-Address (up to 20 digits).
(Up to 36 digits including telephone number, pauses, spaces, FLASH and Sub-address)

TEL. NO.
5551234s2762■

Ex: Telephone number = 5551234, Sub-Address = 2762

Enter as: ⑤ ⑤ ⑤ ① ② ③ ④

FLASH/SUB-ADDR ② ⑦ ⑥ ②

3

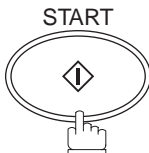

The document(s) are stored into memory and your machine starts to dial the number of the station and sends the document(s) with Sub-Addressing information.

* STORE * NO. 001
PAGES=001 01%

NOTE

1. **FLASH/SUB-ADDR** separates the Sub-Address from the Telephone number and is indicated by an "s" in the display.
2. Manual Off-Hook or On-Hook Dialing cannot be used with the Sub-Addressing Transmission.
3. The Sub-Address is not transmitted during Manual Redial Mode.

Journals and Lists

To help you maintain records of the documents you sent and received, as well as lists of the numbers you record, your facsimile machine is equipped to print the following journals and lists: Transaction Journal, Communication Journal, Directory Search Dialing List and Fax Parameter List.

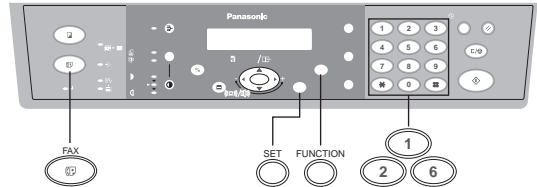

Transaction Journal

The "Journal" is a record of the last 40 transactions (a transaction is recorded each time you send or receive a document). It prints automatically after every 40 transactions (See Note 1) or you can print or view it manually by using the following procedure:

Make sure that the FAX lamp is ON. If not, press **FAX** to select the "FAX MODE".

1

```
PRINT OUT      (1-4)
ENTER NO. OR v ^
```

2

```
JOURNAL
1:PRINT 2:VIEW
```

3a

to print a Journal

```
* PRINTING *
JOURNAL
```

3b

to view a Journal

```
JOURNAL VIEW
1:XMT ONLY 2:ALL
```

Journals and Lists

4

Select the view mode.

- ① to view transmission transactions only
- ② to view all transactions

Ex: ②

You can view the transactions in the journal by pressing

▼ or ▲. Press **STOP** to return to standby.

USE THE ▼ ^ KEYS TO
SCROLL EACH RECORD

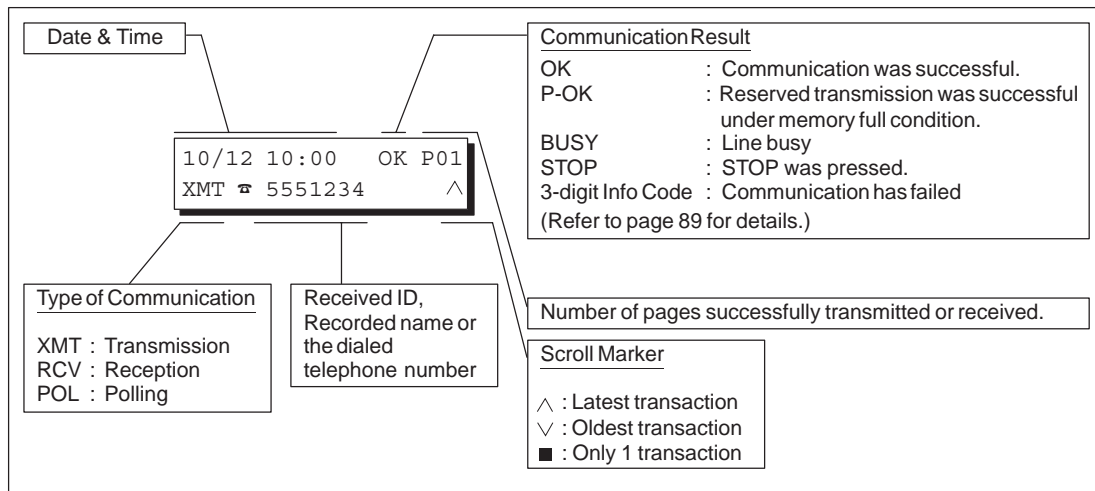

NOTE

- If you wish to disable the automatic printing of the Transaction Journal, change the setting of Fax Parameter No. 13 to "Invalid". (See page 35)

Journals and Lists

Sample Transaction Journal

***** -JOURNAL- ***** (1) (2) DATE OCT-12-2000 ***** TIME 15:00 *****									
(3)	(4)	(5)	(6)	(7)	(8)	(9)	(10)	(11)	(12)
NO.	COMM.	PAGES	FILE	DURATION	X/R	IDENTIFICATION	DATE	TIME	DIAGNOSTIC
01	OK	005/005 004/004 001		00:00:22	RPOL	SERVICE DEPT.	OCT-11	17:35	C0044903C0000
02	OK	003	003	00:01:17	RCV	111 222 333	OCT-11	17:41	C0044903C0000
03	OK	001	004	00:00:31	XMT	ACCOUNTING DEPT.	OCT-11	17:50	C0044903C0000
04	630	000/005	005	00:00:00	XMT	☎342345676	OCT-11	17:57	0800420000000
05	STOP	000	006	00:00:34	XMT	☎12324567	OCT-11	18:35	0210260200000
06	OK	001/001	007	00:00:20	XMT	☎44567345	OCT-11	18:44	C8044B03C0000
07	408	*003	008	00:02:14	XMT	☎2345678	OCT-11	18:55	0040440A30080
39	OK	002/002	049	00:00:31	XMT	☎0245674533	OCT-12	08:35	C8044B03C1000
40	OK	003/003	050	00:01:32	XMT	☎0353678980	OCT-12	08:57	C8044B03C1000
(13) -PANASONIC -									
***** -HEAD OFFICE - ***** 201 555 1212- *****									
(15) (14)									

Journals and Lists

Explanation of contents

- (1) Printout date
- (2) Printout time
- (3) Journal number
- (4) Communication result : "OK" indicates that the communication was successful.
"BUSY" indicates that the communication has failed because of busy line.
"STOP" indicates that **STOP** was pressed during communication.
"M-OK" indicates that the substitute reception message in memory was not printed.
"P-OK" indicates that memory overflow or document misfeeding occurred while storing the documents into memory for transmission but successfully stored document(s) was sent.
"3-digit Info Code" (See page 89) indicates that the communication has failed.
- (5) Number of pages transmitted or received : The 3-digit number is the number of pages successfully transmitted or received. When the documents are stored into memory, two 3-digit numbers will appear. The first 3-digit number represents the number of pages successfully transmitted. The second 3-digit number represents the total number of pages that were attempted to be transmitted.
Asterisk "*" indicates that the quality of some received copies was poor.
- (6) File number : 001 to 999 (If the communication is stored into memory, a file number is assigned for each communication.)
- (7) Duration of communication
- (8) Type of communication : "XMT" means Transmission
"RCV" means Reception
"POL" means Polling
- (9) Remote station identification : Name : Recorded name in the Directory Search Dialing or remote station's Character ID.
☎ number : Dialed telephone number (PIN code will not be shown)
Number : Remote station's ID number.
- (10) Communication date
- (11) Communication Start time
- (12) Diagnostic : For service personnel only
- (13) Own LOGO : Up to 25 characters
- (14) Own ID number : Up to 20 digits
- (15) Own Character ID : Up to 16 characters

Journals and Lists

Communication Journal (COMM. JOURNAL)

The Communication Journal (COMM. Journal) lets you verify whether the transmission or polling was successful. You may select the printout condition (Off/Always/Inc. Only) in Function 8-1 or Fax Parameter No. 12.

Sample COMM. JOURNAL

***** - COMM. JOURNAL - ***** DATE OCT-12-2000 **** TIME 15:00 *****

(1) MODE = MEMORY TRANSMISSION (2) START=OCT-12 14:50 (3) END=OCT-12 15:00

FILE NO.= 050 (4)

(5) STN NO.	(6) COMM.	(7) STATION NAME	(8) TEL NO.	(9) PAGES	(10) DURATION
001	OK	SERVICE DEPT.	021 123 4567	001/001	00:01:30
002	OK	SALES DEPT.	021 321 6754	001/001	00:01:25
003	407	ACCOUNTING DEPT	021 133 1234	000/001	00:01:45
004	BUSY		021 111 1234	000/001	00:00:00

- PANASONIC -

***** - HEAD OFFICE - ***** - 201 555 1212 - *****

THE SLEREXE COMPANY LIMITED

SAPORS LANE - BOOLE - DORSET - BH 25 8 ER

TELEPHONE BOOLE (945 13) 51617 - TELEX 123456

Our Ref. 350/PJC/EAC

18th January, 1972.

Dr. P.N. Cundall,
Mining Surveys Ltd

... variations of print density ...
cause the photocell to generate an analogous electrical video signal.
This signal is used to modulate a carrier, which is transmitted to a
remote destination over a radio or cable communications link.

At the remote terminal, demodulation reconstructs the video
signal, which is used to modulate the density of print produced by a
printing device. This device is scanning in a raster scan synchronised
with that at the transmitting terminal. As a result, a facsimile
copy of the subject document is produced.

Probably you have uses for this facility in your organisation.

Yours sincerely,

Phil.

P.J. CROSS
Group Leader - Facsimile Research

Journals and Lists

Explanation of contents

- (1) Indicates the communication mode
- (2) Start time of communication
- (3) End time of communication
- (4) File number : 001 to 999 (When the communication is stored into memory, a file number is assigned for each communication.)
- (5) Station number : Sequential number of the Stations.
- (6) Communication result : "OK" indicates that the communication was successful.
"BUSY" indicates that the communication has failed because of busy line.
"STOP" indicates that **STOP** was pressed during communication.
"M-OK" indicates that the substitute reception message in memory was not printed.
"P-OK" indicates that memory overflow or document misfeeding occurred while storing the documents into memory for transmission but successfully stored document(s) was sent.
"3-digit Info Code" (See page 89) indicates that the communication has failed. In this case, the machine will print the attached report with the image of the first page of your document as shown on the previous page.
- (7) Station name
- (8) TEL number
- (9) Number of pages transmitted or received : The 3-digit number is the number of pages successfully transmitted or received. When the documents are stored into memory, two 3-digit numbers will appear. The first 3-digit number represents the number of pages successfully transmitted. The second 3-digit number represents the total number of pages that were attempted to be transmitted.
- (10) Duration of Communication

Journals and Lists

Directory Search Dialing List

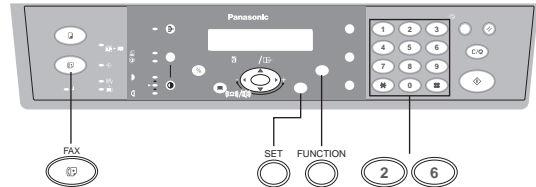

To print the Directory Search Dialing List you have stored.

Make sure that the FAX Mode indicator is ON. If not, press **FAX** to select the "FAX MODE".

1

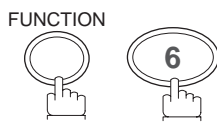

PRINT OUT (1-4)
ENTER NO. OR ∨ ^

2



2:DIR. DIAL LIST ?
PRESS SET TO PRINT

3



* PRINTING *
DIRECTORY DIAL LIST

Journals and Lists

Sample Directory Dial List

```

***** - DIRECTORY DIAL LIST - ***** DATE OCT-12-2000 **** TIME 15:00 *****

(1)                                     (2)
STATION NAME                           TELEPHONE NO.

ACCOUNTING DEPT                         313 333 3456
ENG. DEPT.                              888 555 1234
SALES. DEPT.                            <G>
                                         [1/2] 121 555 1234
                                         [2/2] 222 666 2345

NO. OF STATIONS = 002 (3)
GROUP           = 001 (4)

                                         -PANASONIC -

***** -HEAD OFFICE - ***** -      201 555 1212 - *****

```

Explanation of contents

- (1) Station name recorded in the machine : Up to 15 characters
- (2) Telephone number recorded in the machine : Up to 36 digits
- (3) Number of recorded Directory Search Dialing Stations
- (4) Number of recorded Group Dialing

FAX Parameter List

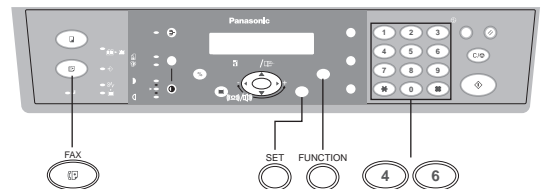

To print a FAX Parameter List:

Make sure that the FAX Mode indicator is ON. If not, press **[FAX]** to select the "FAX MODE".

1

FUNCTION

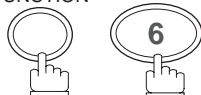

PRINT OUT (1-4)
ENTER NO. ∨ ^

Journals and Lists

2



4:FAX PARAM. LIST?
PRESS SET TO PRINT

3



* PRINTING *
FAX PARAMETER LIST

Journals and Lists

Sample FAX Parameter List

```

***** -FAX PARAMETER LIST- ***** DATE OCT-12-2000 ***** TIME 15:00 *****
(1)      (2)      (3)      (4)      (5)
PARAMETER DESCRIPTION SELECTION CURRENT STANDARD
NUMBER   (7)        SETTING  SETTING
*02     RESOLUTION (HOME) (1:Standard 2:Fine 3:S-Fine) 2 1
05      MEMORY      (HOME) (1:Off      2:On)      2 2
(       (
99     MEMORY SIZE (FLASH) (1MB + 4MB) (6)
- PANASONIC -
***** -HEAD OFFICE - ***** 201 555 1212- *****

```

Explanation of contents

- (1) Parameter number
- (2) Description : "(HOME)" means home position setting.
- (3) Selection
- (4) Current setting : "----" indicates code or password is not set. When the code or password is set, it is shown in parenthesis.
- (5) Standard setting : Factory preset standard setting
- (6) Memory size : (Base memory + option memory)
- (7) Changed setting : " * " indicates that the Factory preset setting was changed.

Troubleshooting

Information Codes

When something unusual occurs, the display may show one of the Information Codes listed below. These will help you to identify and correct the problem.

Info. Code	Meaning	Action	Page
400	During initial handshake, receiving station did not respond or communication error occurred.	1. Check with the other party. 2. Reload the document and send again.	--
401	Remote station required a Receiving Password to receive the document.	Check the remote station.	--
402	During initial handshake, communication error occurred.	Reload the document and send again.	--
403	No polling capability at the remote side.	Ask remote side to set "POLLED=ON".	--
404/405	During initial handshake, communication error occurred.	Reload the document and send again.	--
406	Receiving Password does not match.	Check the password.	67
407	No confirmation from the receiving station for the previous page sent.	Wait a few minutes and send again.	--
408/409	Remote side confirmation of previous page is illegible.	Wait a few minutes and send again.	--
410	Communication aborted by the transmitting side.	Check with the other party.	--
411	Polling password does not match.	Check the polling password.	63
412	No data from the transmitting side.	Check with the other party.	--
414	Polling password does not match.	Check the polling password.	63
415	Polling transmission error.	Check the polling password.	63
416/417 418/419	Received data has too many errors.	Check with the other party.	--
420/421	Machine goes to receiving mode, but receives no command from the transmitting side.	1. Remote side misdial. 2. Check with the other party.	--
422/427	Interface is incompatible.	Check with the other party.	--
430/434	Communication error occurred while receiving.	Check with the other party.	--
436/490	Received data has too many errors.	Check with the other party.	--
492/493 494	Communication error occurred while receiving.	Check with the other party.	--
495	Telephone line disconnected.	Check with the other party.	--

Troubleshooting

Info. Code	Meaning	Action	Page
501/502	Communication error occurred using the internal V.34 Modem.	Check with the other party.	--
540/541 542 543/544	Communication error occurred while transmitting.	1. Reload the document(s) and send again. 2. Check with the other party.	--
550	Telephone line disconnected.	Check with the other party.	--
552/553 554/555	Communication error occurred while receiving.	Check with the other party.	--
580	Sub-Address transmission to a unit that has no Sub-Address function.	Check the remote station.	75
581	Sub-Address Password transmission to a unit that has no Password Sub-Address function.	Check the remote station.	75
601	ADF Paper Feed Cover was opened during ADF transmission.	Close the ADF Paper Feed Cover and send again.	94
623	No document loaded on the ADF.	Reload the document and send again.	--
630	Redial was not successful due to a busy line.	Reload the document and send again.	--
631	During dialing, STOP was pressed.	Reload the document and send again.	--
634	Redial was not successful due to no response from the called station or wrong number dialed. Note: If busy tone was not detected, the machine will only redial once.	Check the telephone number and send again.	--
638	Power failure occurred during the communication.	Check the power cord and plug.	--
870	Memory overflow occurred while storing document(s) into memory for transmission.	1. Transmit document(s) without storing into memory. 2. Install Optional Memory Card.	51 101

NOTE

- After identifying the problem and verifying the recommended action, if the information Codes keep reoccurring or for help on Information Codes that appear on your machine but are not listed above, please contact your local Panasonic Authorized Dealer.
(For mechanical failures, see the Troubleshooting section in the Operating Instructions (For Copier) P.29)

Troubleshooting

If You Have Any of These Problems

Mode	Symptom	Cause / Action	page
During Standby	"JAN-01-1999" appears on the display.	The battery is not installed or the battery is completely discharged. Install a New battery and reset the clock.	93
During Transmission	Document doesn't feed/multiple feeds	1. Check that your document is free of staples and paper clips, and that it is not greasy or torn. 2. Check that your document is the right type to send through an ADF by consulting the list on "Originals You Cannot Send". If your document has the characteristics listed, use the Platen Glass instead.	39 39
	Document jam	"REMOVE MISFED ORIG. IN ADF" will appear on the display if the document jams.	--
Transmission Copy Quality	Vertical lines on the transmitted document	Check own copy quality. If copy is OK, your machine has no problem, report to the receiving party that they have a problem. If copy is NG, clean the Document Scanning Area.	94
	Transmitted document is blank	1. Make sure the document is set face up on the ADF and face down on the Platen Glass. 2. Check own copy quality. If copy is OK, your machine has no problem, report to the receiving party that they have a problem. If copy is NG, clean the Document Scanning Area.	94
During Reception	No recording paper	"ADD PAPER" will appear on the display if the paper runs out.	--
	Recording paper jam	The information code 001 or 002 will appear on the display if the paper jams.	--
	Recording paper doesn't advance into machine	Make sure that there is paper in the Paper Tray. Follow the instructions for loading paper.	--
	Recording paper doesn't eject after printing	Check to see if the recording paper is jammed inside of the machine.	92
	Recording papers are not stacked in sequence. Machine does not print from the last page received.	If memory becomes full during reception, the machine will start to print from the 1st received page. We recommend that optional flash memory card is installed if this symptom occurs frequently.	101
	Document auto reduction doesn't work	Check Print Reduction settings.	59
	Out of toner	"ADD TONER" will appear on the display if the Toner Cartridge runs out of toner.	--

Troubleshooting

Mode	Symptom	Cause / Action	page
Print Copy Quality	Vertical lines printing on the received document	Print a Journal report (e.g. FUNCTION, 6, 1, SET and 1) and check the quality to make sure whether your machine has trouble. If the Journal report quality is OK, your machine has no problem, report to the sending party that they have a problem. If copy is NG, replace the Toner Cartridge.	79 --
	Fuzzy print	1. Make sure you are using the correct paper for the best possible print quality. 2. Try reversing the recording paper to the other side.	--
	Missing dots or lines/ inconsistent darkness within print	1. Make sure you are using the correct paper for the best possible print quality. 2. Replace the Toner Cartridge.	-- --
	Fading print	Your Toner Cartridge may be running out of toner. Replace the Toner Cartridge.	--
	Faint print	You may need to choose a different paper for the best possible print quality.	--
Communication	No dial tone	1. Check the connection of the telephone line. 2. Check the telephone line.	97
	No auto answer	1. Check the connection of the telephone line. 2. Check the Reception mode setting. 3. If the Fax Parameter No. 13 (AUTO JOURNAL PRINT) is set to "Valid" (default setting) and the machine is printing the received document from memory, which also happens to be the 40th transaction, the machine will not auto answer until the Transaction Journal completes printing.	97 58
	Cannot transmit or receive	An information code will be shown on the display. Refer to the information code table to find out the trouble.	89
No Unit Operation	No unit operation	To reset the machine, turn-off the Power Switch for a few seconds then turn it on again.	--

Adding Paper

See Operating Instructions (For Copier) P.21

Adding Toner

See Operating Instructions (For Copier) P.23

Removing Paper Jams

See Operating Instructions (For Copier) P.25 ~ 28

Troubleshooting

Replacing the Lithium Battery

When "JAN-01-1999" appears on the display, replace the Lithium Battery by following the procedure below.

1

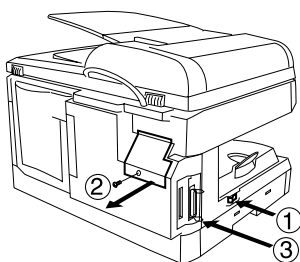

- ① Turn the Power Switch to the "O" (OFF) position.
- ② Remove the Rear Access Cover. (1 Screw)
- ③ Discharge the static electricity by touching the parallel printer connector.

2

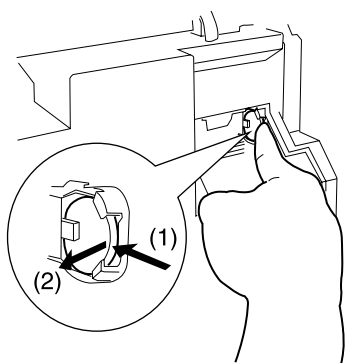

- ④ Remove the Lithium Battery from the battery holder.

3

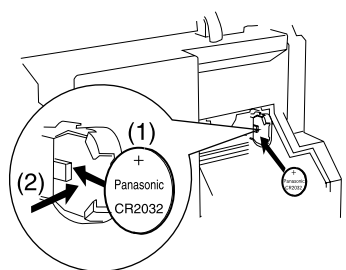

- ⑤ Install a New Lithium Battery into the battery holder.

⚠ CAUTION

denotes hazards that could result in minor injury or damage to the machine.

- Keep the Lithium Battery away from small children.
 - To prevent damage to the machine, ensure that the (+) positive polarity (Panasonic Logo) is facing towards you.
 - Replace only with the same (Panasonic CR2032), or equivalent type.
 - Dispose of used battery according to the instructions of your Local Solid Waste Officials.
- ⑥ Reinstall the Rear Access Cover. (1 Screw)
 - ⑦ Turn the Power Switch to the "I" (ON) position.
 - ⑧ Reset the Date and Time (see page 21).

Troubleshooting

Cleaning the Document Scanning Area

Copier Care

- Wipe marks off with cloth and a neutral detergent.
- Wipe again with a dry cloth.

Scanning Area Care

If the receiving party reports that the received documents were black, or contain black lines, try making a copy on your unit to verify.

If the copy is black or has black lines, the Document Scanning Area is probably dirty and must be cleaned.

If document misfeeding occurs frequently, clean the feeding roller.

- Wipe the area gently with soft cloth after wringing it dry.

- 1** Open the Paper Feed Cover and wipe the Paper Feed Roller gently.

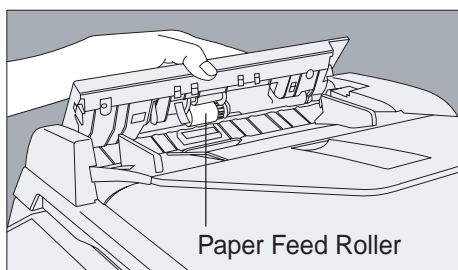

- 3** Open the ADF and wipe the Platen Glass and the Platen Cover gently.

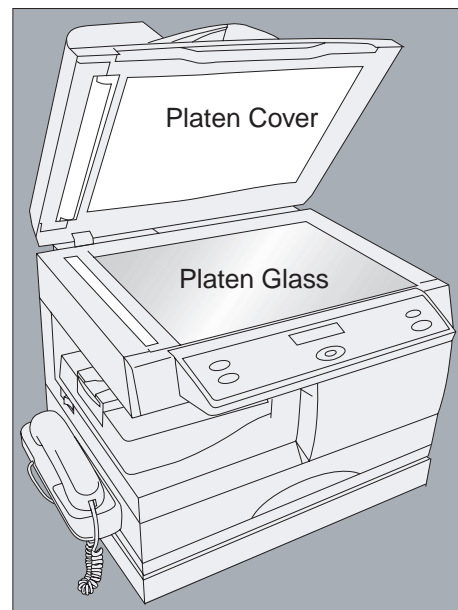

- 2** Close the Paper Feed Cover securely.

- 4** Close the ADF.

NOTE

1. Be careful not to scratch the scanning area.

Troubleshooting

Cleaning the Printer Roller

If you find toner on the back of the recording paper, the printer roller in the fuser unit is probably dirty.

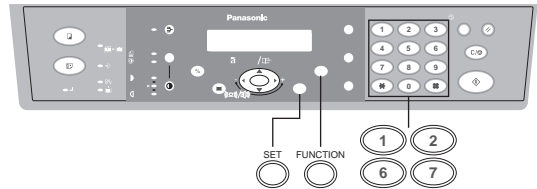

To clean the printer roller

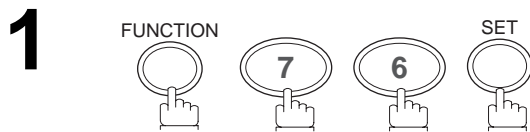

CLEANING CHARTS
1:PRINT 2:CLEAN



* PRINTING *
CLEANING CHARTS

The machine will print out 3 Cleaning Charts.
Then, return to standby.

<PRINTER ROLLER CLEANING CHART>

HOW TO LOAD THE CLEANING CHARTS

- 1.OPEN THE PAPER TRAY
(If multiple paper tray configuration, OPEN THE UPPER PAPER TRAY)
- 2.SET THESE 3 CLEANING CHARTS IN THE PAPER TRAY FACE DOWN
- 3.CLOSE THE PAPER TRAY
- 4.PRESS [FUNCTION] [7] [6] [SET] [2] TO START CLEANING
- 5.DISPOSE OF THE CLEANING CHARTS



*** SET THIS END TOWARDS THE RIGHT, FACE DOWN ***

Troubleshooting

- 3** Load the Cleaning Charts into the paper tray face down.
(See Note 1)

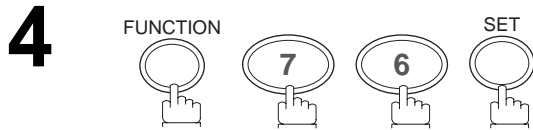

CLEANING CHARTS
1:PRINT 2:CLEAN



* CLEANING *
PRINTER ROLLER

The Machine will feed the charts and clean the printer roller.

NOTE

1. If you have installed the optional paper tray(s), load the Cleaning Charts into the upper paper tray.

Checking the Telephone Line

Checking the Telephone Line

If you do not hear a dial tone when the **MONITOR** key is pressed, nor through the telephone connected to the machine or when the telephone does not ring (No automatic receive).

1

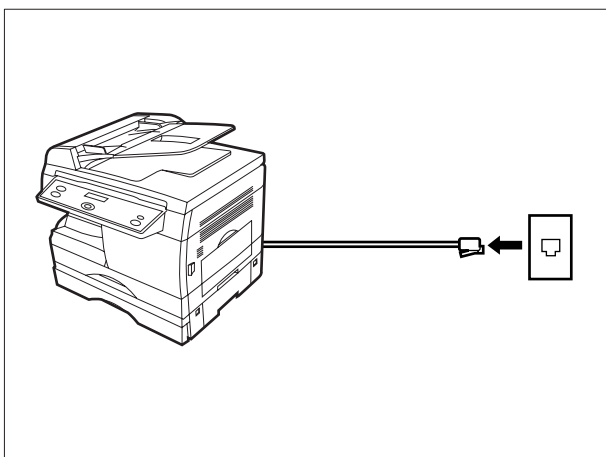

Unplug the Telephone Line Cable from the telephone jack that was supplied by the telephone company.

2

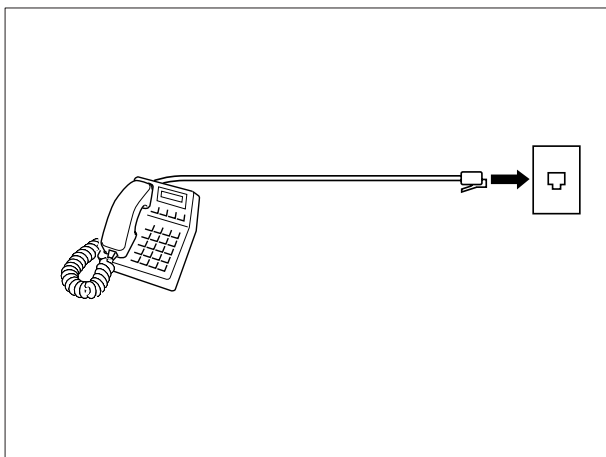

Plug a different regular telephone into the same telephone jack.

3

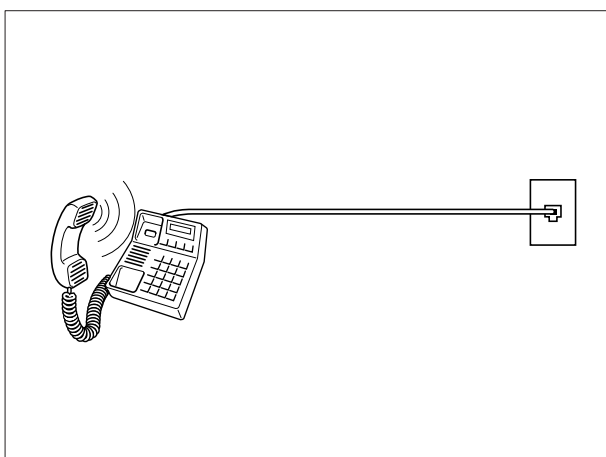

Check for dial tone through the handset. If there is still no dial tone, report it to your local telephone company.

or

Call from another telephone to this number. If the telephone does not ring, report it to your local telephone company.

This page is intentionally left blank.

Specifications

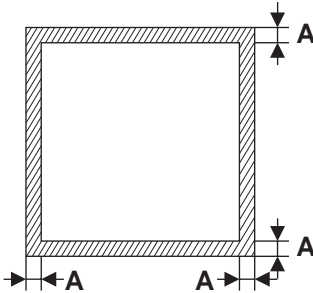
Compatibility	ITU-T Group 3
Coding Scheme	MH, MR, MMR (Conforms to ITU-T Recommendations)
Modem Type	ITU-T V.34, V.17, V.29, V.27 ter and V.21
Modem Speed	33600 ~ 2400 bps
Original Size (ADF)	B4/Legal/Letter/Invoice Max. Original Size Platen Glass : B4 (10.1 in x 14.3 in) ADF : 10.1 in x 6 ft Min. Original Size Platen Glass : No minimum ADF : 5.1 in x 5.8 in
Original Thickness (ADF)	0.0024 (13 lbs) - 0.0049 (28 lbs)
ADF Capacity (Automatic Document Feeder)	Built-in, Up to 30 pages
Scanning Method	Sheet Feeding or Flatbed with CCD type image sensor
Effective Scanning Width	10.0 in (257 mm)
Scanner Resolution	Horizontal: 203 pels/inch (8 pels/mm) : Standard and Fine Resolution : 406 pels/inch (16 pels/mm) : Super Fine Resolution Vertical : 98 lines/inch (3.85 lines/mm) : Standard Resolution : 196 lines/inch (7.7 lines/mm) : Fine Resolution : 391 lines/inch (15.4 lines/mm): Super Fine Resolution
Recording Method	Laser/Electrostatic photographic method
Recording Paper	Plain Paper
Printer Resolution	600 dpi
Recording Paper Size	Legal/Letter/Invoice
Effective Recording Size	Legal : 8.1" x 13.6" (205.7 x 345.4 mm) Letter : 8.1" x 10.6" (205.7 x 269.2 mm) Invoice: 5.1" x 8.1" (129.5 x 205.7 mm)
Print Margin	 <p>5 mm margin on each side of paper A : 0.20 inch (5 mm)</p>

Specifications are subject to change without notice.

Specifications

Recording Paper Capacity	250 sheet paper tray, plus 50 sheet bypass
Directory Search Dialing Memory Capacity	100 stations (10 group dialing are included. Each group dialing can register up to 10 stations.) Each station can register up to 36 digits for each telephone number (including pauses, spaces, Flash, sub-address and tone) and up to 15 characters for each station name
Image Memory Capacity	Base Memory 60 pages with 1 MB Flash Memory Card 120 pages with 2 MB Flash Memory Card 180 pages with 4 MB Flash Memory Card 300 pages (Based on ITU-T Image No. 1 chart, using Standard Resolution)
Power Supply	AC 120V, 50/60 Hz, 8A
Power Consumption	Energy Saver Mode : Approx. 35 Wh Sleep Mode : Approx. 1.5 Wh Maximum : Approx. 1.0 kW
Dimensions	19.5" (W) x 19.2" (D) x 15.1" (H) (with ADF)
Weight	50 lbs
Operating Environment	Temperature: 50 to 90 °F Relative Humidity: 30 ~ 80 %
FCC Registration Number	BTL PHL-35379-FA-E
Ringer Equivalence	USA : 2.0B Canada: 0.9

Specifications are subject to change without notice.



NOTE

1. The left and right print margin is 0.22 in (5.5 mm) when printing a Letter or Legal size document with 600 dpi from a PC using the Parallel Port Interface Kit.

Options and Supplies

Please contact your local Panasonic dealer for availability.

A. Options:

Order No.	Picture	Description
UE-403171-AU		Handset Kit
UE-410045		Expansion Flash Memory Card, 1 MB
UE-410046		Expansion Flash Memory Card, 2 MB
UE-410047		Expansion Flash Memory Card, 4 MB

Options and Supplies

Installing the Handset Kit

1

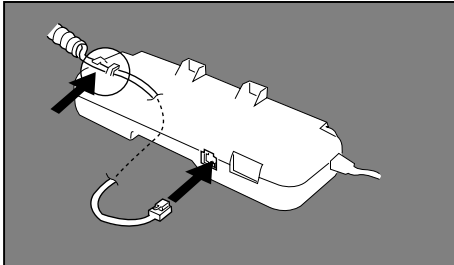

Turn the Power Switch OFF when installing the handset kit. Remove the handset kit out of the carton. Connect the handset cord to the handset cradle.

2

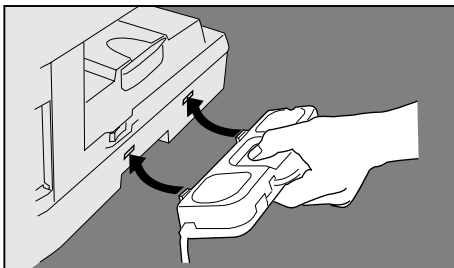

Hook the projections of the handset cradle into square holes on the left side of the machine.

3

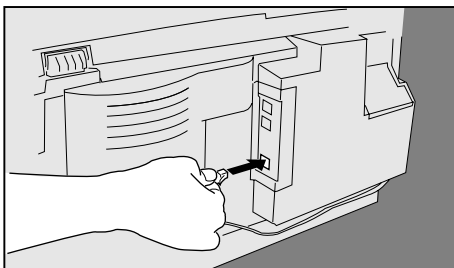

Connect the cable from the handset cradle into the HANDSET jack on the rear of the machine.

4

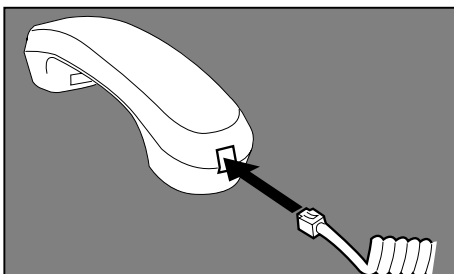

Connect the handset cord into the receiver. Place the receiver on the cradle. Turn the Power Switch ON.

NOTE

1. Turn the Power Switch OFF when installing the handset kit.

Options and Supplies

Expansion Flash Memory Card

Installing the Expansion Flash Memory Card (1 MB: UE-410045, 2 MB: UE-410046, 4 MB: UE-410047)

Before installing, make sure that there is no document file(s) stored in memory. To confirm, observe the standby display while the machine is in the FAX Mode and ensure that "00%" percentage is shown. When the memory card is installed, the machine initializes the document memory, and erases all contents stored in the document memory.

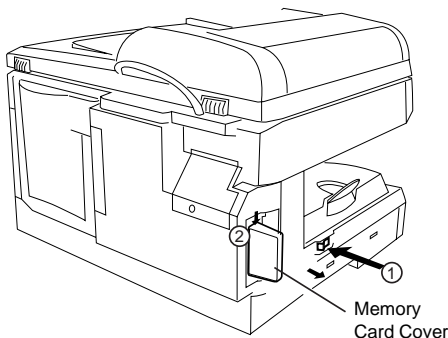

- ① Turn the Power Switch OFF.
- ② Remove the Memory Card Cover.
- ③ Gently insert the Memory Card into the card slot.

Important: The Panasonic logo on the Memory Card must be facing toward the front of the copier.

CAUTION

- Do not install or remove the memory card while the power switch is ON.

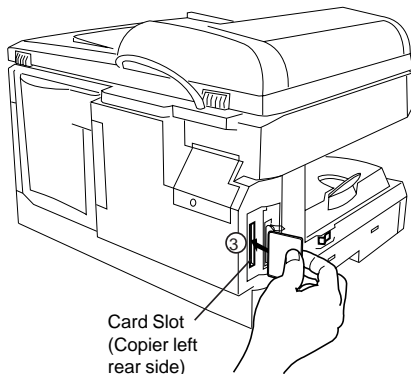

- ④ Re-install the Memory Card Cover.
- ⑤ Turn the Power Switch ON.
- ⑥ Print the Fax Parameter List (See page 87) and confirm that the memory size on Fax Parameter No. 99. (See page 37 and the Note 1 below)

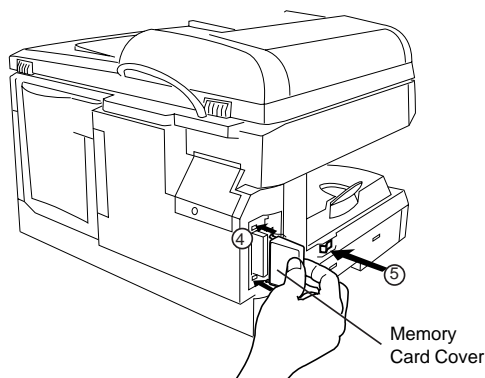

NOTE

1. Document(s) stored in memory will be lost if the Memory Card is removed.

FCC Notice for User in USA

WARNING

This equipment has been tested and found to comply with the limits for a Class A digital device, pursuant to part 15 of the FCC Rules. These limits are designed to provide reasonable protection against harmful interference when the equipment is operated in a commercial environment. This equipment generates, uses, and can radiate radio frequency energy and, if not installed and used in accordance with the Operating Guide, may cause harmful interference to radio communications.

Operation of this equipment in a residential area is likely to cause harmful interference in which case the user will be required to correct the interference at his/her own expense.

Any unauthorized changes or modifications to this equipment would void the users authority to operate this device.

Ask your telephone company or installer to install the jack suitable for your device if such is not available.

The REN is useful to determine the quantity of devices you may connect to your telephone line and still have all of those devices ring when your telephone number is called. In most, but not all areas, the sum of the REN's of all devices connected to one line should not exceed five (5.0). To be certain of the number of devices you may connect to your line, as determined by the REN, you should contact your local telephone company to determine the maximum REN for your calling area.

If your telephone equipment causes harm to the telephone network, the Telephone Company may discontinue your service temporarily. If possible, they will notify you in advance. But if advance notice isn't practical, you will be notified as soon as possible. You will be informed of your right to file a complaint with FCC.

Your telephone company may make changes in it's facilities, equipment, operations or procedures that could affect the proper functioning of your equipment. If they do, you will be notified in advance to give you an opportunity to maintain uninterrupted telephone service.

If you experience trouble with this telephone equipment, please contact the manufacturer's authorized service agency for information on obtaining service or repairs. The telephone company may ask that you disconnect this equipment from the network until the problem has been corrected or until you are sure that the equipment is not malfunctioning.

WARNING

For protection against the risk of electric shock, always disconnect all cables from the wall outlet before servicing, modifying or installing the equipment.

This equipment may not be used on coin service provided by the telephone company nor connected to party lines.

NOTE

- This equipment complies with Part 68 of the FCC Rules. On the rear panel of this equipment is a label that contains, among other information, the FCC Registration Number and Ringer Equivalence Number (REN) for this equipment.
You must, upon request, provide this information to your telephone company.*

FCC Notice for User in USA

The telephone Consumer Protection Act of 1991 makes it unlawful for any person to use a computer or other electronic device to send any message via telephone facsimile machine unless such message clearly contains in a margin at the top or bottom of each transmitted page or on the first page of transmission the following information:

- 1) Date and Time of transmission; and,
- 2) Identification of either business, business entity or individual sending the message: and,
- 3) Telephone number of either the sending machine, business, business entity or individual.

In order to program this information into your facsimile machine, you should refer to:

- For Date and Time (See page 21)
- For Logo, Character ID and ID Number (See page 22 to 24)

Example of Header Format (LOGO, ID Number setting)

OCT-12-2000 09:00	PANASONIC	201 348 7000	P.01/05
↑	↑	↑	
1) Date and Time	2) LOGO	3) ID Number	

Notice for User in Canada

NOTICE

The Industry Canada Label identifies certified equipment. This certification means that the equipment meets certain telecommunications network protective, operational and safety requirements. The Department does not guarantee the equipment will operate to the user's satisfaction.

Before installing this equipment, users should ensure that it is permissible to be connected to the facilities of the local telecommunications company. The equipment must also be installed using an acceptable method of connection. The customer should be aware that compliance with the above conditions may not prevent degradation of service in some situations.

Repairs to certified equipment should be made by an authorized Canadian maintenance facility designated by supplier. Any repairs or alterations made by the user to this equipment, or equipment malfunctions, may give the telecommunications company cause to request the user to disconnect the equipment.

Users should ensure for their own protection that the electrical ground connections of the power utility, telephone lines and internal metallic water pipe system, if present, are connected together.

This precaution may be particularly important in rural areas.

CAUTION

Users should not attempt to make such connections themselves, but should contact the appropriate electric inspection authority, or electrician, as appropriate.

NOTICE

The ringer equivalence number (REN) assigned to each terminal device provides an indication of the maximum number of terminals allowed to be connected to a telephone interface. The termination on an interface may consist of any combination of devices subject only to the requirement that the sum of the ringer equivalence numbers of all the devices does not exceed 5.

Notice for User in Canada

Avis

L'étiquette de Industrie Canada identifie le matériel homologué. Cette étiquette certifie que le matériel est conforme à certaines normes de protection, d'exploitation et de sécurité des réseaux de télécommunications. Le Ministère n'assure toutefois pas que le matériel fonctionnera à la satisfaction de l'utilisateur. Avant d'installer ce matériel, l'utilisateur doit s'assurer qu'il est permis de le raccorder aux installations de l'entreprise locale de télécommunication. Le matériel doit également être installé en suivant une méthode acceptée de raccordement. L'abonné ne doit pas oublier qu'il est possible que la conformité aux conditions énoncées ci-dessus n'empêche pas la dégradation du service dans certaines situations. Les réparations de matériel homologué doivent être effectuées par un centre d'entretien canadien autorisé désigné par le fournisseur. La compagnie de télécommunications peut demander à l'utilisateur de débrancher un appareil à la suite de réparations ou de modifications effectuées par l'utilisateur ou à cause de mauvais fonctionnement. Pour sa propre protection, l'utilisateur doit s'assurer que tous les fils de mise à la terre de la source d'énergie électrique, des lignes téléphoniques et des canalisations d'eau métalliques, s'il y en a, sont raccordé ensemble. Cette précaution est particulièrement importante dans les régions rurales.

Avertissement

L'utilisateur ne doit pas tenter de faire ces raccordements lui-même; il doit avoir recours à un service d'inspection des installations électriques, ou à un électricien, selon le cas.

Avis

L'indice d'équivalence de la sonnerie (IES) assigné à chaque dispositif terminal indique le nombre maximal de terminaux qui peuvent être raccordés à une interface. La terminaison d'une interface téléphonique peut consister en une combinaison de quelques dispositifs, à la seule condition que la somme d'indices d'équivalence de la sonnerie de tous les dispositifs n'excède pas 5.

Glossary

ADF (Automatic Document Feeder)	The mechanism that delivers a stack of document pages to the scanner one page at a time.
Auto Print Reduction	The method of automatically reducing a received document so that it can be printed onto a standard size piece of plain paper. For example, your machine will reduce an incoming legal size page to 75% of its original size so it could fit on a letter size page.
Batch Transmission	The ability to accumulate different documents for the same destination(s) to be transmitted in a single phone call.
Character ID	A programmed proprietary code name that allows up to 16 alphanumeric characters identifying your facsimile machine.
Coding Scheme	The data compression method used by facsimile machines. Your machine utilizes Modified Huffman (MH), Modified Read (MR), Modified Modified Read (MMR) and Joint Bi-level Experts Group (JBIG) coding schemes.
Comm. Journal	Refers to either the Communication Journal or Relay Transmission Report.
Contrast	Signifies the scanning sensitivity in terms of lightness and darkness of your original transmitting pages.
DDD (Direct Distance Dialing)	A telephone service that allows unassisted dialing, no operator assistance is required.
Direct Dialing	The method of dialing where you enter the entire telephone number through the keypad.
Directory Search Dialing	Allows you to dial a full telephone number by searching the station's name entered in the One-Touch keys or Abbreviated dialing numbers.
DTMF (Dual Tone Multi-Frequency)	Dialing method that sends a different set of frequencies for each digit of the telephone keypad. Commonly refers to touch tone dialing.
ECM (Error Correction Mode)	The ability to correct transmission errors as detected during the transmitting phone call.
Energy-Saver Mode	Saves energy by consuming less power than when in standby mode by turning off the fuser unit after the specified time.
FAX Parameter List	The list that contains the home FAX parameters settings that you have programmed into your machine.
F.C.C.	Federal Communications Commission. The U.S. Government organization that regulates communications originating or terminating in the United States.
File	A task that has been stored into the memory of your unit. Examples are deferred transactions.
Fixed Print Reduction	The method that allows you to determine one reduction rate, such as 90%~100%, for all incoming documents.
G3 Mode (Group 3)	Refers to the standards and transmission capabilities of the current generation of facsimile machines.

Glossary

Group Dialing	The ability to program many telephone numbers into a single station so that many locations can be dialed in sequence utilizing a single keystroke.
Header	A row of information that is transmitted by the sending machine and printed on the top of each page by the receiving unit. This identifies the transmitting unit and information about the transmission, such as time and date.
ITU-T	International Telecommunication Union - Telecommunication.
ITU-T Image No.1	An industry standard document that allows comparisons of the transmission speeds and capabilities of facsimile machines.
ID	A programmable address of up to 20 digits identifying your machine.
Image Memory Capacity	This signifies the amount of memory available in your unit capable of storing pages of documents. All page units of measure are based on the ITU-T Image No.1.
Industry Canada (D.O.C)	Department of Communications. The Canadian Government organization that regulates communications originating or terminating in Canada.
Information Code	A code that is internally generated by your Fax stating a specific operational error or machine failure.
Journal	A report that is printed by your unit listing the last 40 transactions.
Keypad	A group of numeric keys located on your control panel.
LOGO	Your programmed company name or identification up to 25 alphanumeric characters.
Manual Reception	A mode that requires operator intervention to receive an incoming document.
Memory Transmission	The documents are scanned into memory before actual connection to the phone line for transmission.
Modem	A device that converts signals from your fax machine into signals that can be transmitted over telephone lines.
Multi-Station Transmission	The ability to broadcast the same set of documents to a programmed number of locations.
Off-hook Dialing	The direct dialing of a telephone number with the handset out of the cradle or "off the hook".
On-hook Dialing	The direct dialing of a telephone number by pressing MONITOR Key.
Polling	The ability to retrieve a document from another facsimile machine.
Polling Password	A 4-digit programmed code that enables the security of a document being polled.
Print Reduction Modes	The methods used to determine how an incoming document will be reduced to print onto the paper loaded in your machine.

Protocol	A protocol is the special set of rules for communicating that the end points in a telecommunication connection use when they send signals back and forth. Both end points must recognize and observe the protocol.
PSTN	Public Switched Telephone Network. Network of interconnected switching equipment and transmission facilities.
Resolution	Relates to the number of dots scanned or printed per certain square. The quality of the image increases as the number of dots per certain square increases.
Selective Reception	A function that can be set so that your unit will receive from only those machines programmed into your dialer.
Station Name	Alphanumeric ID which can be programmed for each One-Touch dialing and Abbreviated dialing number.
Stored Documents	Documents that have been scanned and now are stored in your machine's memory.
Sub-Address	ITU-T recommendation for further routing, forwarding or relaying of incoming faxes.
Sub-Address Password	ITU-T recommendation for additional security that corresponds to the Sub-address.
Substitute Memory Reception	Your machine's ability to store an incoming document into its memory, when it runs out of recording paper or toner.
Transmission Reservation	The ability to preset a telephone number so that you may reserve a transmission while your unit is performing another function.
Transmission Password	A 4-digit password that is checked when a document is transmitted.
User Parameter	Programmed parameters that provide information to other stations. Examples are logo, character ID, date and time.
View Mode - File List	Allows you to view the brief contents of the memory files through the LCD display without having to print the Memory File List.
View Mode - Journal	Allows you to view the brief contents of the journal through the LCD display without having to print the journal.

ITU-T Image No.1

All specifications are based on the ITU-T Image No. 1 (The sample shown below is not to scale).

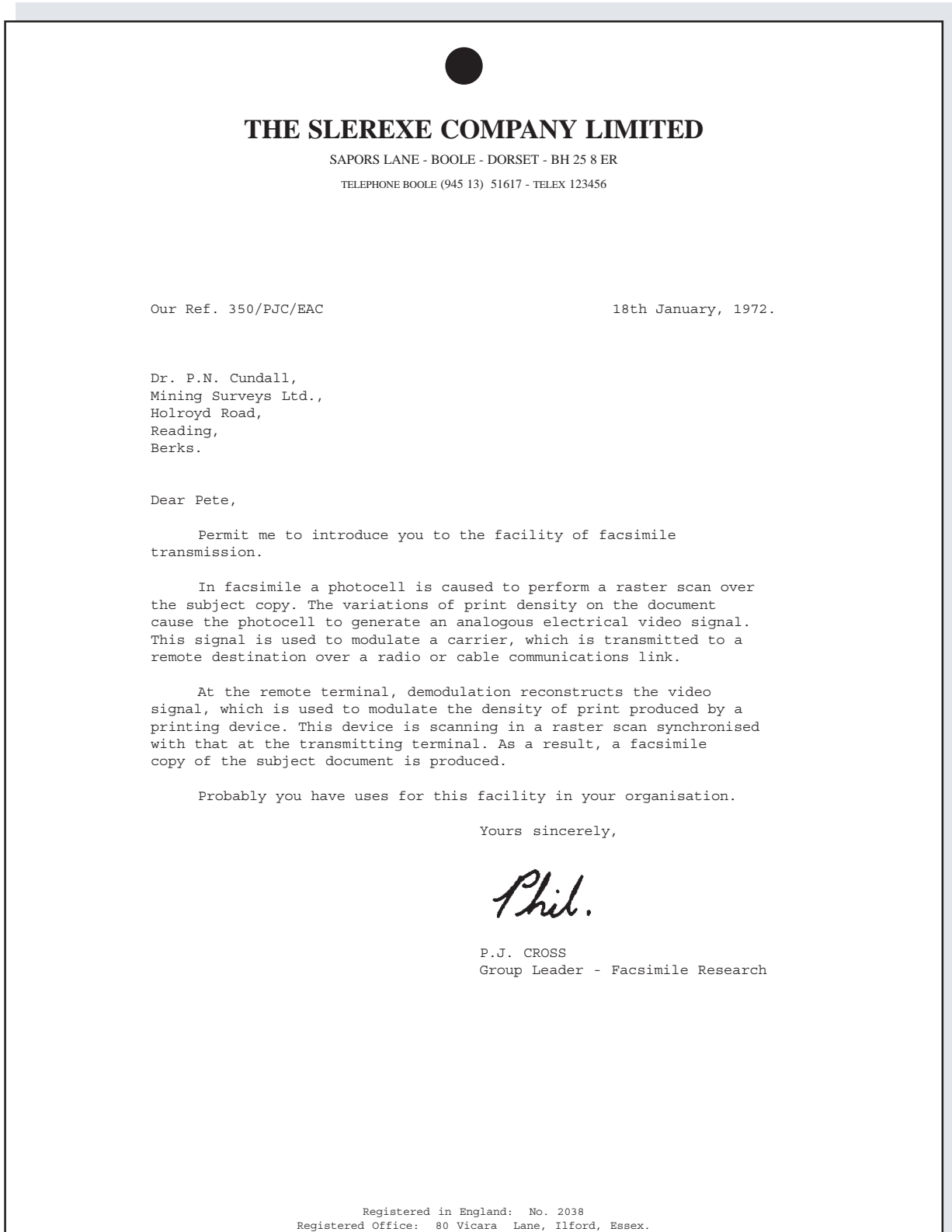

This page is intentionally left blank.

INDEX

A		M	
Automatic Reception	58	Manual Number Dialing.....	45
Automatic Reduction	59	Memory Card.....	101
C		Memory Transmission.....	43
Character ID.....	23	Monitor Volume	18
Communication Journal (COMM. JOURNAL).....	42, 83	Multi-Station Transmission	49
Contrast.....	40	O	
Copy Mode.....	16	Off-Hook Dialing.....	54
D		On-Hook Dialing.....	55
Date and Time.....	21	Original Mode.....	40
Diagnostic Password.....	36	P	
Dialing Method (Tone or Pulse)	17	PIN Code Access	72
Direct Transmission	51	Polling.....	63
Directory Search	25	Polling Password.....	63
Directory Search Dialing	27, 47	Print Reduction.....	59
Directory Search Dialing List.....	85	R	
Distinctive Ring Detector (DRD).....	71	Receive To Memory	67
E		Redialing	57
Edit File Mode	66	Reduction Ratio.....	35
F		Resolution	40
Fax Mode	16	Ringer Volume.....	18
FAX Parameter List.....	87	S	
Fax Parameter Table	35	Single Station	25
Fixed Reduction	59	Sub-Address Password.....	36
G		Sub-addressing	73
Group Dialing	30	Substitute Memory Reception	61
H		T	
Header Format	35	Transmission Reservation.....	56
Header Print	35	U	
I		User Parameters	21
ID Number	24		
J			
Journal	79		
K			
Key/Buzzer Volume.....	35		
L			
Loading Documents	39		
Logo	22		

U.S.A. Only

WARRANTY

"PANASONIC DOCUMENT IMAGING COMPANY MAKES NO WARRANTIES, GUARANTEES OR REPRESENTATIONS, EXPRESSED OR IMPLIED, TO CUSTOMER WITH RESPECT TO THIS PANASONIC COPIER, INCLUDING BUT NOT LIMITED TO, ANY IMPLIED WARRANTY OF MERCHANTABILITY OR FITNESS FOR A PARTICULAR PURPOSE.

PANASONIC DOCUMENT IMAGING COMPANY ASSUMES NO RISK AND SHALL NOT BE SUBJECT TO LIABILITY FOR ANY DAMAGE, INCLUDING, BUT NOT LIMITED TO DIRECT, INDIRECT, SPECIAL, INCIDENTAL OR CONSEQUENTIAL DAMAGES OR LOSS OF PROFITS SUSTAINED BY THE CUSTOMER IN CONNECTION WITH THE USE OR APPLICATION OF THIS PANASONIC COPIER. SEE YOUR DEALER FOR DETAILS OF DEALER'S WARRANTY."

For Service, Call: _____

Panasonic Document Imaging Company
A Division of Matsushita Electric Corporation of America
Two Panasonic Way
Secaucus, New Jersey 07094

FFPTD11012 S0301-2
March 2001
Printed in Japan